

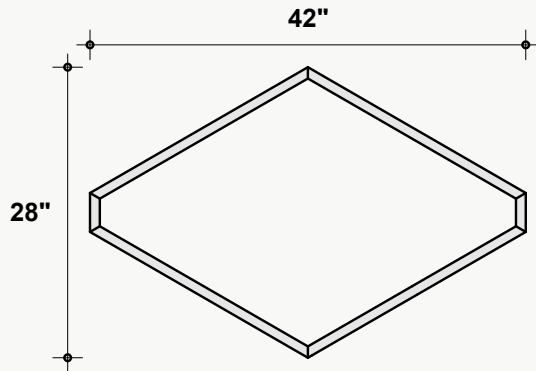

# Dimensions

## Standard Unit Dimensions

Typical ranges for length and width.



## Standard Unit Thicknesses

Thickness is independent on material layer selection.

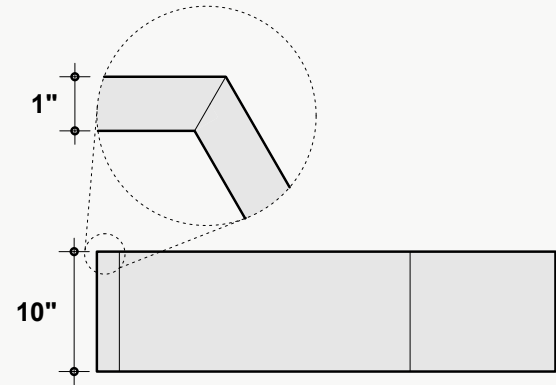

## Custom Opportunity

Product dimensions can be manipulated in order to fit your design aesthetic and site conditions.

## Product Details

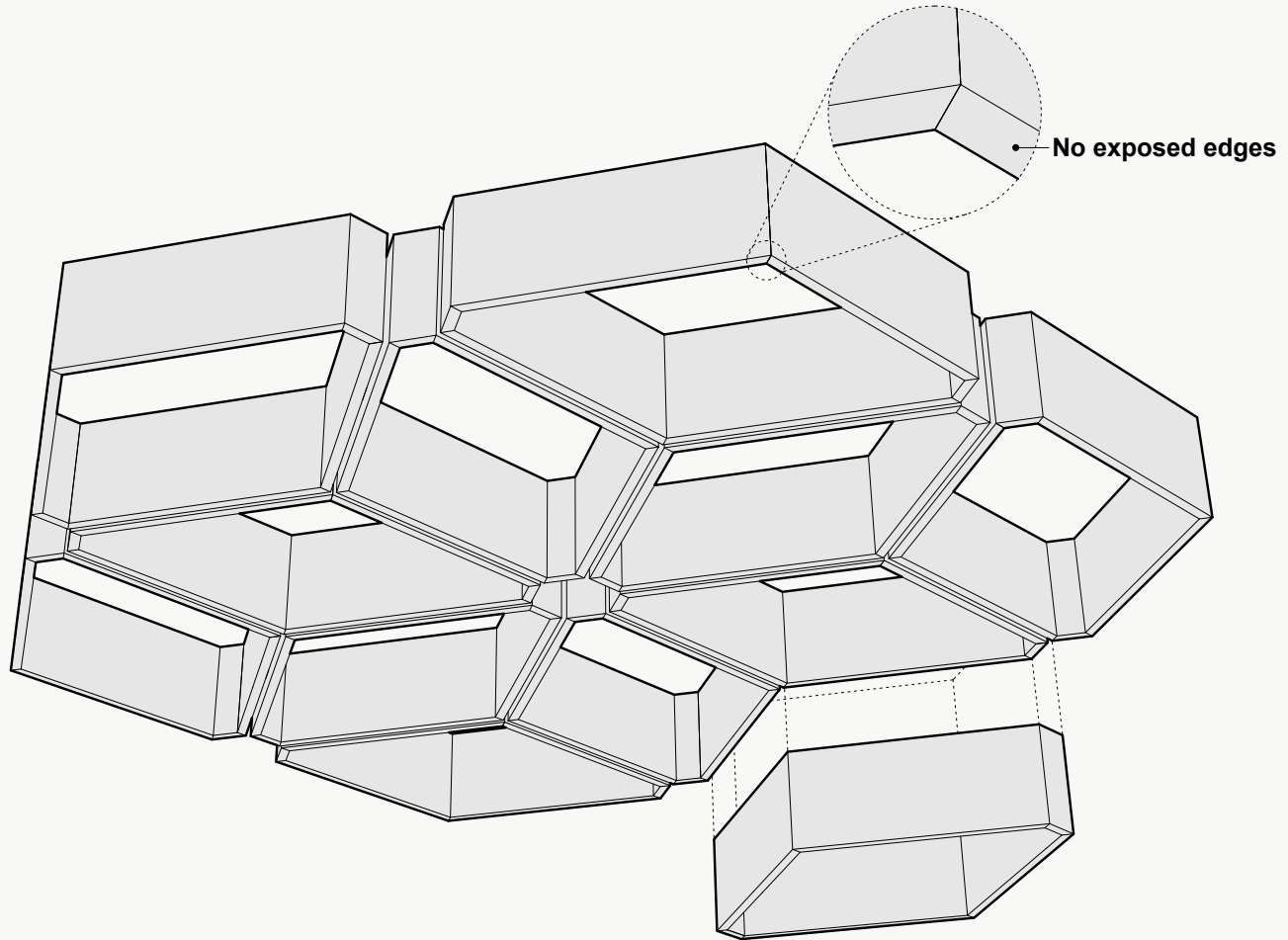

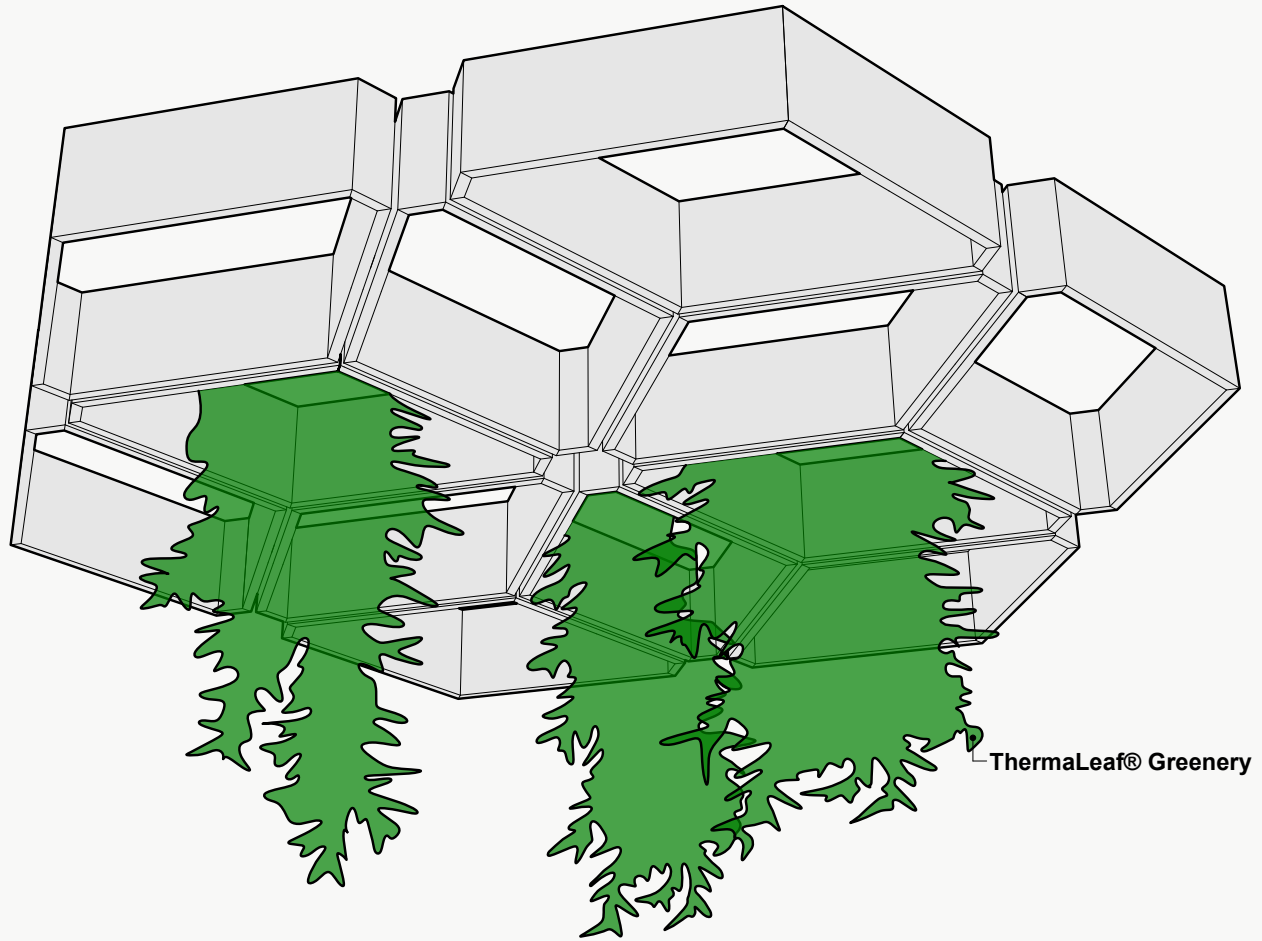

ThermaLeaf® Greenery

# ThermaLeaf® Greenery

Commercial Silk International's trademarked ThermaLeaf® artificial foliage is a proprietary formulation and manufacturing process whereby the fire retardants are impregnated directly into the raw materials of the foliage resulting in an inherently fire retardant "IFR" product.

- + ASTM E84-95 Class A Fired Rated
  - + Injected, non-topical treatment will not wash or wear off
  - + Long lasting, consistent fire protection
- 

## Available Greenery Configurations



Jasmine, White  
Jasmine, Salmon



Sweet Bay



Silver Inch Plant



Algerian Ivy



Algerian Ivy, Variegated



Grape Ivy



Lace Ivy



Lace Ivy, Variegated

# ThermaLeaf® Greenery

Commercial Silk International's trademarked ThermaLeaf® artificial foliage is a proprietary formulation and manufacturing process whereby the fire retardants are impregnated directly into the raw materials of the foliage resulting in an inherently fire retardant "IFR" product.

- + ASTM E84-95 Class A Fired Rated
  - + Injected, non-topical treatment will not wash or wear off
  - + Long lasting, consistent fire protection
- 

## Available Greenery Configurations



English Ivy



Golden Pothos



Heartleaf Philodendron



Heartleaf Philodendron,  
Limelight



Virginia Creeper

## Attachment Methods\*

### Aircraft Cable

- + Fastest/easiest height adjustment
- + Largest height adjustment range
- + Height and angle versatility
- + Accommodates uneven ceiling surfaces and MEP

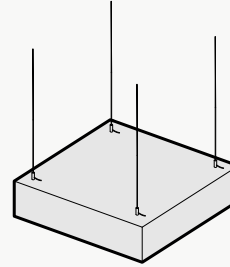

### Threaded Rod

- + Reduced product sway
- + Height and angle versatility
- + Accommodates uneven ceiling surfaces and MEP

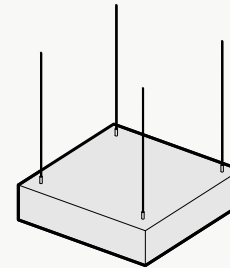

### Mechanical Direct

- + Lowest profile installation method
- + Eliminates product sway
- + Connects to: Unistrut, ACT Grid, flat ceiling surfaces
- + Connections: Magnets, Grid Clips, Panel Clips, Metal Bracket, Custom

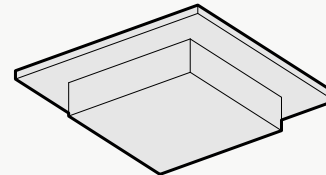

\*Not all listed attachment methods may be applicable to this product.



## Material Layers

### Soundcore®

Our recycled PET felt creates an acoustic barrier, defending against wandering white noise and irritating echoes.

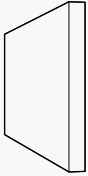

**Single Layer**  
½" Thickness

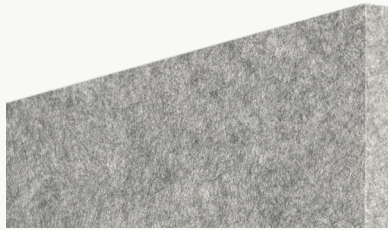

### Soundcore® Wood Textures

Soundcore® wood textures provide the natural aesthetic of wood while maintaining all the acoustic benefits of PET felt. Custom texture opportunities are also available upon request.

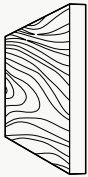

**Single Layer**  
½" Thickness



Soundcore® | 1/2" Thickness

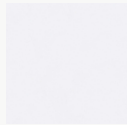

SND019  
Linen

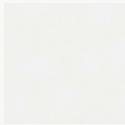

SND037  
Paper



SND134  
Oat



SND135  
Vanilla Bean



SND105  
Sand Dollar



SND109  
Macadamia



SND111  
Lanai



SND130  
Buckskin



SND131  
Abalone

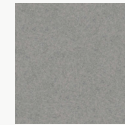

SND125  
Chinchilla



SND118  
Anchor



SND126  
Wolfhound



SND110  
Starry Night



SND102  
Morning Fog

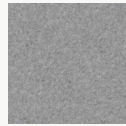

SND114  
Lunar Dust

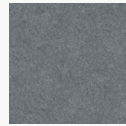

SND034  
Granite Peak

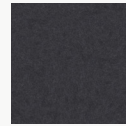

SND132  
Cast Iron



SND103  
Storm Cloud



SND038  
Inkwell



SND122  
Briquette



SND127  
Burnt Toast



SND108  
Ablaze



SND104  
Pumpkin



SND141  
Terracotta



SND106  
Goldfinch



SND107  
Grasshopper

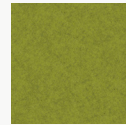

SND113  
Gruner



SND143  
Olive

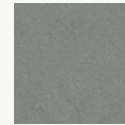

SND129  
Dried Thyme

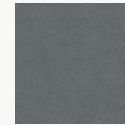

SND115  
Mako



SND136  
Clover



SND138  
Fern

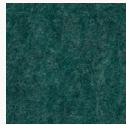

SND137  
Cove



SND112  
Tulum



SND139  
Tidal



SND121  
Apatite



SND123  
Chrysocolla



SND117  
Serene

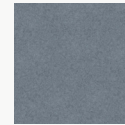

SND124  
Ice Floe

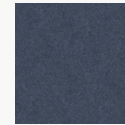

SND128  
Arctic Ocean

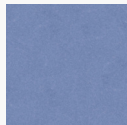

SND042  
Denim

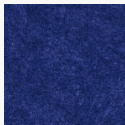

SND101  
Commodore



SND140  
Marine



SND133  
Galactic



SND142  
Fig

Soundcore® Wood Textures | 1/2" Thickness



**SND716**  
Dark Teak



**SND792**  
Dark Oak



**SND715**  
Dark Cherry



**SND793**  
Vintage Maple



**SND794**  
Warm Teak



**SND714**  
English Walnut



**SND713**  
Honey Walnut



**SND717**  
Warm Oak

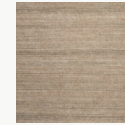

**SND790**  
Natural Teak

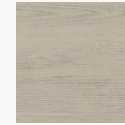

**SND712**  
Natural Spruce



**SND711**  
Bleached Cherry

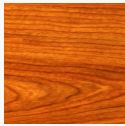

**SND796**  
Vintage Cherry



**SND795**  
Light Teak



**SND709**  
White Maple



**SND791**  
Gray Oak

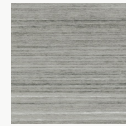

**SND710**  
Gray Teak