



# Product Specifications

<b>Product Name</b>	Tile Grid 007
<b>Product ID</b>	GRD-TLE-007
<b>Acoustics</b>	0.75 - 0.80 NRC*
<b>Lead Time</b>	Lead time is dependent on project size. Contact us for more information.
<b>Durability</b>	Contract

<b>Warranty</b>	Comes with industry-leading standard warranty.
<b>Flammability</b>	ASTM E84: Class A
<b>Custom</b>	Custom colors and manufacturing services available. Additional charges and lead times may apply.
<b>Maintenance</b>	Vacuum occasionally to remove airborne dust or debris. Mild detergents or soaps may be used to remove stains. For detailed care instructions, refer to the <b>CSI Creative Maintenance Information</b> document.

# Material Specifications

	<b>Soundcore®</b>	<b>PoshFelt®</b>
<b>Content</b>	Recycled PET acoustic felt	100% Merino or Karakul wool acoustic felt
<b>Weathering</b>	Colorfast, non-deteriorating, non-hygroscopic	Colorfast, non-deteriorating, non-woven, moisture resistant
<b>Environmental</b>	Recycled PET acoustic felt is 60% post-consumer recycled content and is 100% recyclable. Contributes points toward LEED v4, CDPH v1.2, VOC free, non-toxic, non-allergenic, anti-microbial - does not attract mold and mildew. Compliant with Living Building Challenge criteria & DECLARE Red List Free.	100% organic wool design felt is a rapidly renewable resource and is 100% biodegradable/compostable. Contributes points toward LEED v4, CDPH v1.2, VOC free, no chemical irritants, no formaldehyde, and is free of other harmful substances. Compliant with Living Building Challenge criteria & DECLARE Red List Free.
<b>Variation</b>	PET felt panels are created through a manufacturing process known as 'felting'. This process results in a heathered appearance. Multiple color tones may appear in the same panel. Slight color variations should be expected.	Due to its 100% natural origin, the raw fibers of wool felt contain inclusions and color variations throughout the material. Color matching is not guaranteed between dye lots and inconsistencies may be more prominent in volumes that exceed the normal commercial standard.

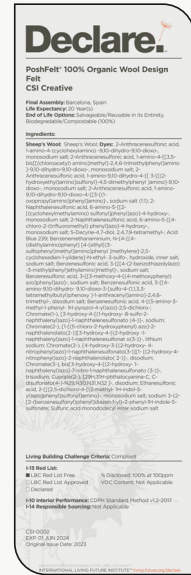
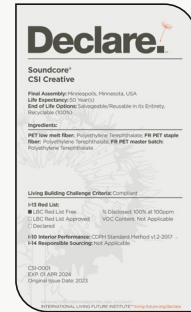

\*Approximate. NRC rating may vary due to product dimensions and spacing.

# Dimensions

## Standard Unit Dimensions

Typical ranges for length and width.

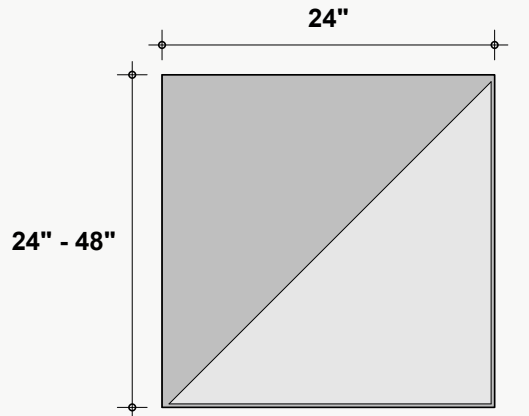

**\*Available in lengths of 24\" & 48\"**

## Custom Opportunity

Product dimensions can be manipulated in order to fit your design aesthetic and site conditions.

## Standard Unit Thicknesses

Thickness is dependent on material layer selection.

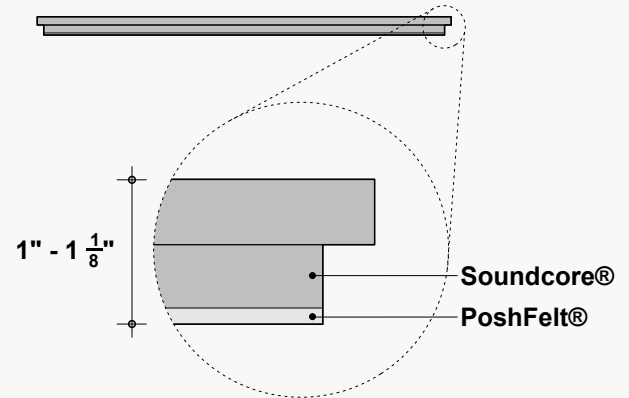

## Product Details

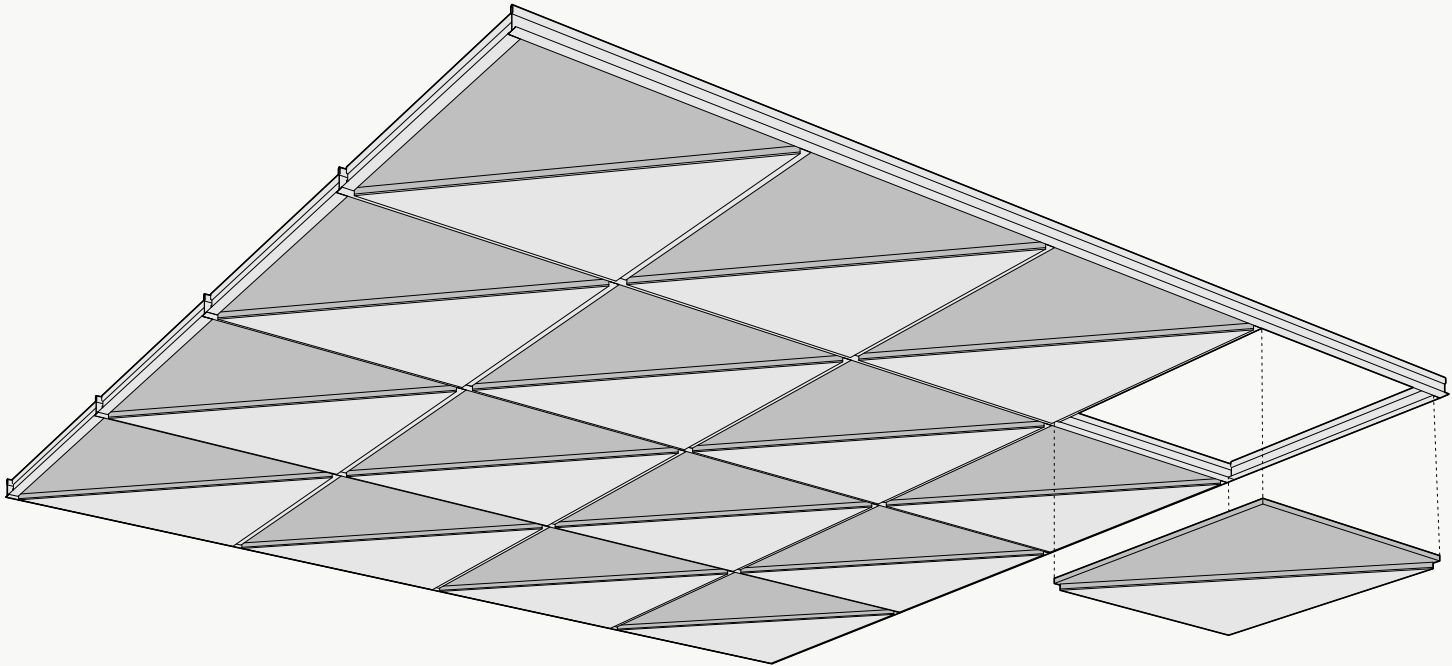

## Configuration Options

*The layouts shown are a summation of individual units. Individual units may be assembled in various arrangements to dictate the larger design. Configurations shown are suggested, but can be rearranged to achieve a custom layout.*

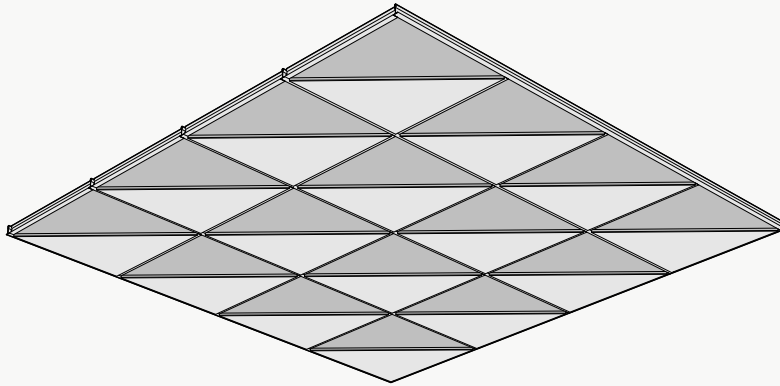

**Uniform**

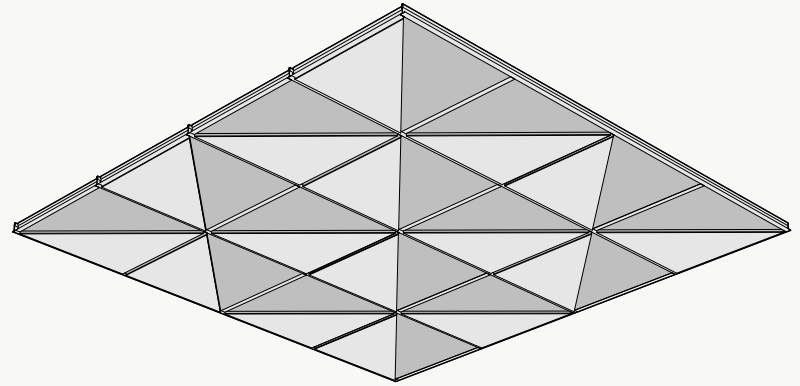

**Patterned**

## Installation Options\*

All products and installation methods can be **customized** to meet the unique requirements of your space.

### Above Grid Installation

- + Easy to install, adjust, and remove
- + Replaces existing mineral tiles
- + Substrate based, no hardware needed

Available methods: Drop-In

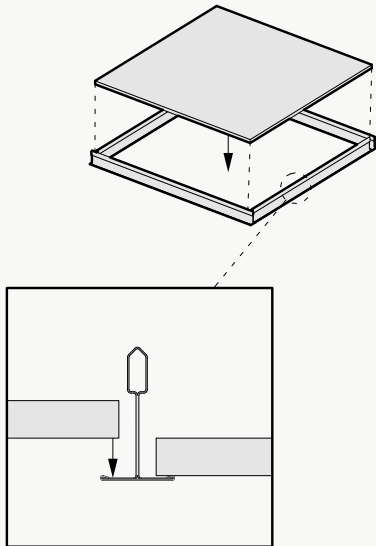

### Below Grid Installation

- + Visually obstructs metal grid structure
- + 1/4" gap between tiles

Available methods: Press-Fit

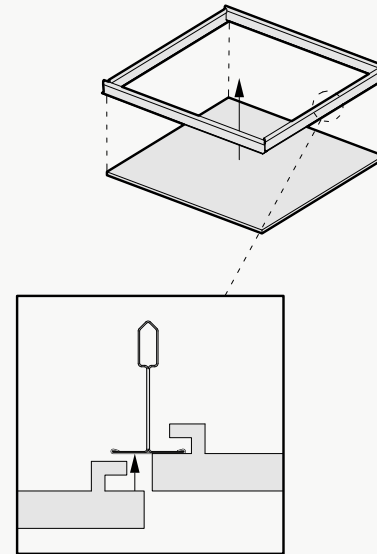

\*Not all listed attachment methods may be applicable to this product.

## Material Layers

### Soundcore®

Our recycled PET felt creates an acoustic barrier, defending against wandering white noise and irritating echoes.

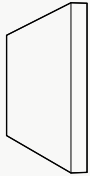

Single Layer  
½" Thickness

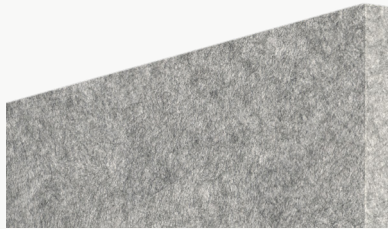

### Soundcore® Wood Textures

Soundcore® wood textures provide the natural aesthetic of wood while maintaining all the acoustic benefits of PET felt. Custom texture opportunities are also available upon request.

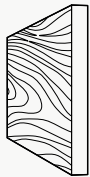

Single Layer  
½" Thickness



### PoshFelt® Exposed Edge



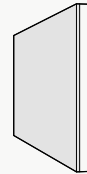

100% organic, natural wool design felt brings out the best experience in your space with color, comfort, and simple sustainability. Exposed edge products leave the Soundcore® layer uncovered, allowing for unique color combinations.



Multi-Layer  
Adds ⅛"-¼" to Material Thickness

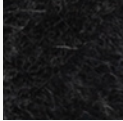
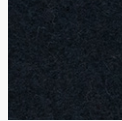
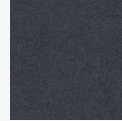

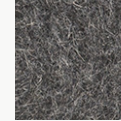
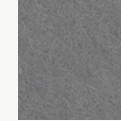
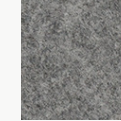
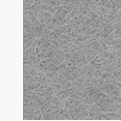
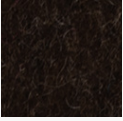
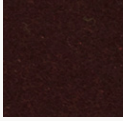
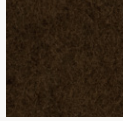
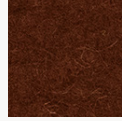
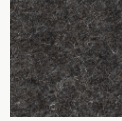
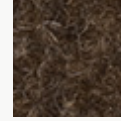
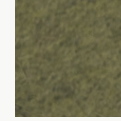
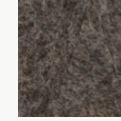
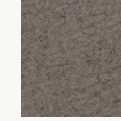
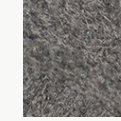
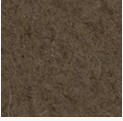
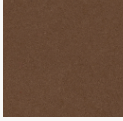
PoshFelt® | 3mm Thickness

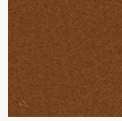
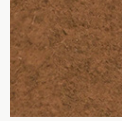
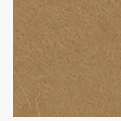
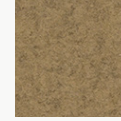
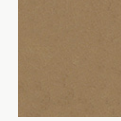
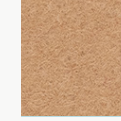
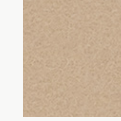
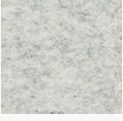
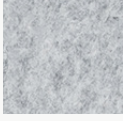
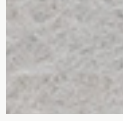
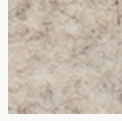
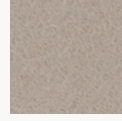
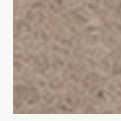
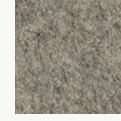
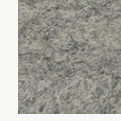
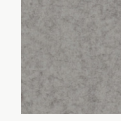
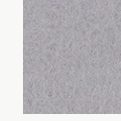
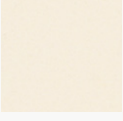
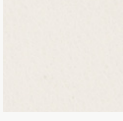
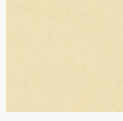
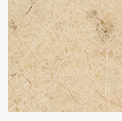
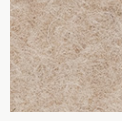
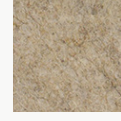
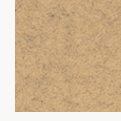
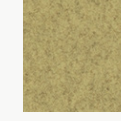
									
<b>PSH005</b> Black Beauty	<b>PSH161</b> Black Swan	<b>PSH266</b> Koala	<b>PSH627</b> Blackberry	<b>PSH265</b> Slag	<b>PSH513</b> Gravel	<b>PSH001</b> Gray Matter	<b>PSH004</b> Porpoise	<b>PSH176</b> Warmstone	<b>PSH512</b> Ash Plume
									
<b>PSH545</b> Henna	<b>PSH249</b> French Press	<b>PSH146</b> Auburn	<b>PSH521</b> Cocoa	<b>PSH179</b> Arctic Seal	<b>PSH180</b> Iron Ore	<b>PSH505</b> Garrigue	<b>PSH003</b> Otter	<b>PSH520</b> Silt	<b>PSH002</b> Heather
									
<b>PSH504</b> Earth	<b>PSH255</b> Tropical Walnut	<b>PSH269</b> Canyon	<b>PSH253</b> Toffee	<b>PSH602</b> Cafe	<b>PSH281</b> Great Plains	<b>PSH503</b> Savanna	<b>PSH509</b> Cairo	<b>PSH621</b> Pan	<b>PSH291</b> Gobi
									
<b>PSH299</b> Mountain Breeze	<b>PSH300</b> Crevasse	<b>PSH625</b> Silver Chain	<b>PSH515</b> Blizzard	<b>PSH127</b> Mocha	<b>PSH635</b> Eggshell	<b>PSH178</b> Fawn	<b>PSH175</b> Dovetail	<b>PSH624</b> Dapple Gray	<b>PSH609</b> Cityscape
									
<b>PSH118</b> Ivory Lace	<b>PSH174</b> Cotton	<b>PSH293</b> Pound Cake	<b>PSH519*</b> Cupcake	<b>PSH630</b> Sand Dune	<b>PSH006</b> Shiitake	<b>PSH301</b> Tumbleweed	<b>PSH637</b> Chiffon	<b>PSH304</b> Sugar Cookie	<b>PSH541</b> Banana Bread

\*6-roll MOQ



PoshFelt® | 3mm Thickness



**PSH215**  
Raincoat



**PSH622**  
Corn



**PSH295**  
Sunrise Peach



**PSH507**  
Hive



**PSH015**  
Honey



**PSH305**  
Dandelion

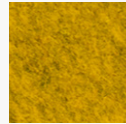

**PSH216**  
Lion's Den



**PSH634**  
Amber



**PSH261**  
Pale Ale



**PSH638**  
Sunflower



**PSH610**  
Coral



**PSH632**  
Peach



**PSH218**  
Citrus



**PSH532**  
Harvest



**PSH014**  
Knockout Orange

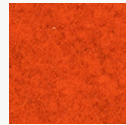

**PSH307**  
Orange Nectar



**PSH633**  
Clementine



**PSH245**  
Fire Agate



**PSH525**  
Olympus



**PSH640**  
Rusted

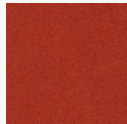

**PSH139**  
Cayenne



**PSH535**  
Guppy

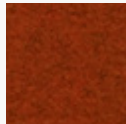

**PSH528**  
Ferrous



**PSH296**  
Paprika



**PSH530**  
Hot Iron

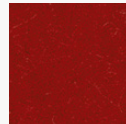

**PSH537**  
Cardinal

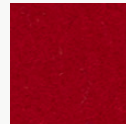

**PSH008**  
Bonfire



**PSH308**  
Scarlet

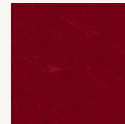

**PSH009**  
Poinsettia

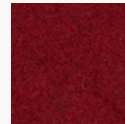

**PSH527**  
Red Velvet



**PSH137**  
Passion Flower



**PSH273**  
Ultraviolet

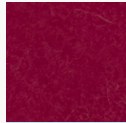

**PSH649**  
Pomegranate

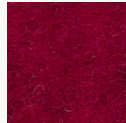

**PSH617**  
Evening Gown

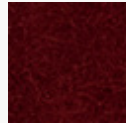

**PSH540**  
Devil's Food

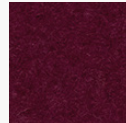

**PSH644**  
Maroon

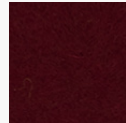

**PSH210**  
Sangria

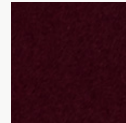

**PSH211**  
Cherry Chutney

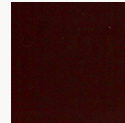

**PSH212**  
Vino

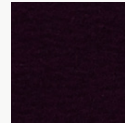

**PSH514**  
Red Wine



**PSH272**  
Hotwire

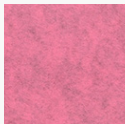

**PSH302**  
Heather Pink



**PSH202**  
Crush

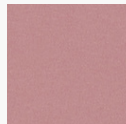

**PSH647**  
Eden Rose

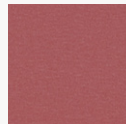

**PSH643**  
Rhododendron

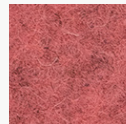

**PSH560**  
Schiava

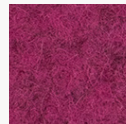

**PSH559**  
Monroe

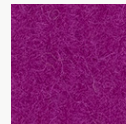

**PSH544**  
Dragonfruit

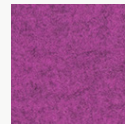

**PSH309**  
Allium

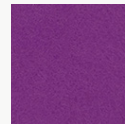

**PSH205**  
Mulberry

PoshFelt® | 3mm Thickness

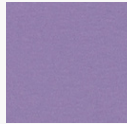

**PSH612**  
Lilac



**PSH646**  
Lupine



**PSH274**  
Amethyst



**PSH523**  
Violet Sky



**PSH546**  
Tyrian Plum



**PSH142**  
Plum Purple



**PSH286**  
Viper

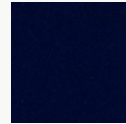

**PSH241**  
Tranquilo

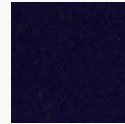

**PSH550**  
Mariana

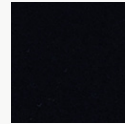

**PSH277**  
Shade

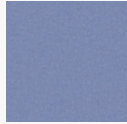

**PSH615**  
Imagine

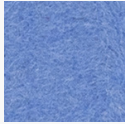

**PSH510**  
Ozone



**PSH237**  
Hotspring



**PSH508**  
Oahu

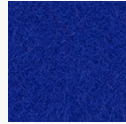

**PSH548**  
Ultramarine

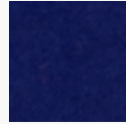

**PSH160**  
Admiral Blue



**PSH239**  
Speckled Navy



**PSH561**  
Neptune



**PSH645**  
Space



**PSH614**  
Blueberry



**PSH502**  
Pacific



**PSH238**  
Cobalt



**PSH152**  
Blue Nile



**PSH616**  
Fountain

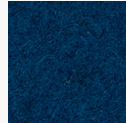

**PSH516**  
Actun



**PSH511**  
Lagoon

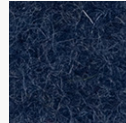

**PSH636**  
Navy Blue

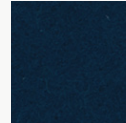

**PSH260**  
Twilight

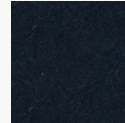

**PSH310**  
Deep Royal



**PSH278**  
Squid Ink



**PSH606**  
Midday



**PSH306**  
Swell

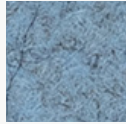

**PSH608**  
Diamond Dust

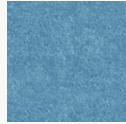

**PSH605**  
Meander



**PSH628**  
Cozumel



**PSH016**  
Freshwater



**PSH650**  
Waterfall



**PSH149**  
Jamaica Bay

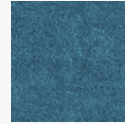

**PSH604**  
Atlantic

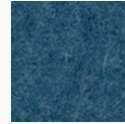

**PSH648**  
Aegean

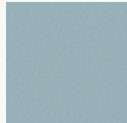

**PSH639**  
Glacier

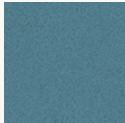

**PSH287**  
Sea Breeze

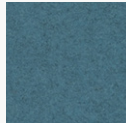

**PSH631**  
Adriatic

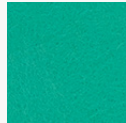

**PSH232**  
Seaglass



**PSH629**  
Robin's Egg

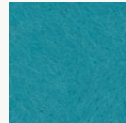

**PSH517**  
Sky Stone

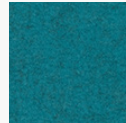

**PSH552**  
Cancun

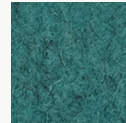

**PSH642**  
Blue Spruce

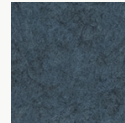

**PSH623**  
Steel Gray

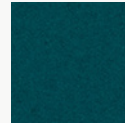

**PSH564**  
Jazz

PoshFelt® | 3mm Thickness



**PSH618**  
Iguana



**PSH641**  
Basil

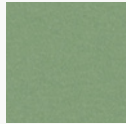

**PSH619**  
Springtime

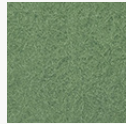

**PSH213**  
Meadow

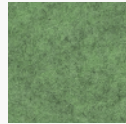

**PSH303**  
Feather Moss



**PSH226**  
Grove



**PSH298**  
Peacock



**PSH234**  
Ocean Trench



**PSH311**  
Emerald



**PSH626**  
Evergreen



**PSH225**  
Everglade



**PSH164**  
Fresh Lime



**PSH554**  
Cyber Green



**PSH555**  
Hemlocks



**PSH012**  
Shamrock

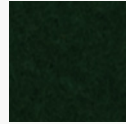

**PSH228**  
Forest Haze

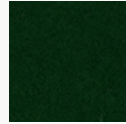

**PSH227**  
Succulent

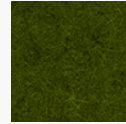

**PSH563**  
Rosemary

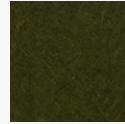

**PSH501**  
Mire



**PSH506**  
Bracken

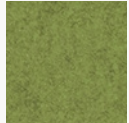

**PSH562**  
Aurora

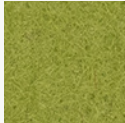

**PSH556**  
Avocado

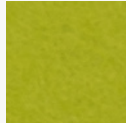

**PSH013**  
Parakeet

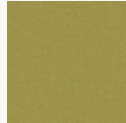

**PSH611**  
Haybale

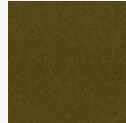

**PSH312**  
Safari

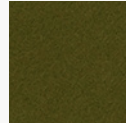

**PSH230**  
Camouflage

Soundcore® | 1/2" Thickness

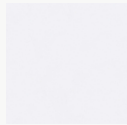

SND019  
Linen

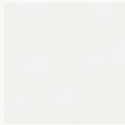

SND037  
Paper

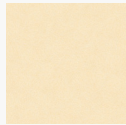

SND134  
Oat



SND135  
Vanilla Bean



SND105  
Sand Dollar



SND109  
Macadamia



SND111  
Lanai



SND130  
Buckskin

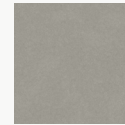

SND131  
Abalone

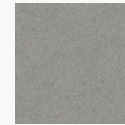

SND125  
Chinchilla



SND118  
Anchor



SND126  
Wolfhound



SND110  
Starry Night



SND102  
Morning Fog

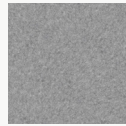

SND114  
Lunar Dust

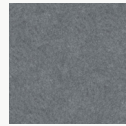

SND034  
Granite Peak

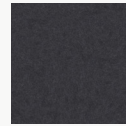

SND132  
Cast Iron



SND103  
Storm Cloud



SND038  
Inkwell



SND122  
Briquette



SND127  
Burnt Toast



SND108  
Ablaze



SND104  
Pumpkin



SND106  
Goldfinch

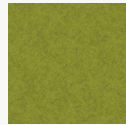

SND113  
Gruner

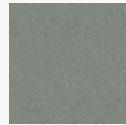

SND129  
Dried Thyme



SND107  
Grasshopper

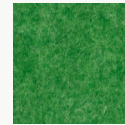

SND136  
Clover

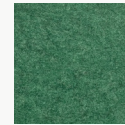

SND138  
Fern

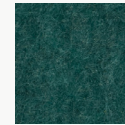

SND137  
Cove



SND112  
Tulum



SND139  
Tidal



SND121  
Apatite

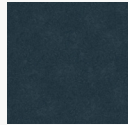

SND123  
Chrysocolla



SND117  
Serene



SND124  
Ice Floe

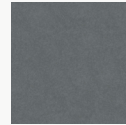

SND115  
Mako

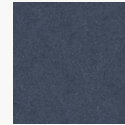

SND128  
Arctic Ocean

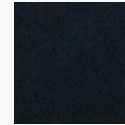

SND133  
Galactic



SND116  
Blue Marlin

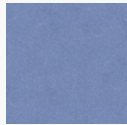

SND042  
Denim



SND140  
Marine

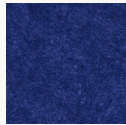

SND101  
Commodore

Soundcore® Wood Textures | 1/2" Thickness



**SND716**  
Dark Teak



**SND792**  
Dark Oak



**SND715**  
Dark Cherry



**SND793**  
Vintage Maple

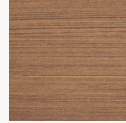

**SND794**  
Warm Teak

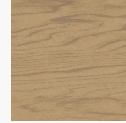

**SND714**  
English Walnut

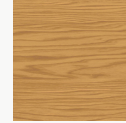

**SND713**  
Honey Walnut

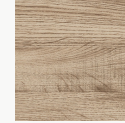

**SND717**  
Warm Oak

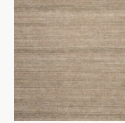

**SND790**  
Natural Teak

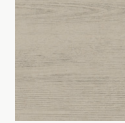

**SND712**  
Natural Spruce



**SND711**  
Bleached Cherry



**SND795**  
Light Teak



**SND709**  
White Maple



**SND791**  
Gray Oak



**SND710**  
Gray Teak