

Product Specifications

Product Name	Stacked Surfaces 023
Product ID	SUR-STK-023
Acoustics	0.50 - 0.60 NRC*
Lead Time	Lead time is dependent on project size. Contact us for more information.
Durability	Contract

Warranty	Comes with industry-leading standard warranty.
Flammability	ASTM E84: Class A
Custom	Custom colors and manufacturing services available. Additional charges and lead times may apply.
Maintenance	Vacuum occasionally to remove airborne dust or debris. Mild detergents or soaps may be used to remove stains. For detailed care instructions, refer to the CSI Creative Maintenance Information document.

Material Specifications

	Soundcore®	PoshFelt®
Content	Recycled PET acoustic felt	100% Merino or Karakul wool acoustic felt
Weathering	Colorfast, non-deteriorating, non-hygroscopic	Colorfast, non-deteriorating, non-woven, moisture resistant
Environmental	Recycled PET acoustic felt is 60% post-consumer recycled content and is 100% recyclable. Contributes points toward LEED v4, CDPH v1.2, VOC free, non-toxic, non-allergenic, anti-microbial - does not attract mold and mildew. Compliant with Living Building Challenge criteria & DECLARE Red List Free.	100% organic wool design felt is a rapidly renewable resource and is 100% biodegradable/compostable. Contributes points toward LEED v4, CDPH v1.2, VOC free, no chemical irritants, no formaldehyde, and is free of other harmful substances. Compliant with Living Building Challenge criteria & DECLARE Red List Free.
Variation	PET felt panels are created through a manufacturing process known as 'felting'. This process results in a heathered appearance. Multiple color tones may appear in the same panel. Slight color variations should be expected.	Due to its 100% natural origin, the raw fibers of wool felt contain inclusions and color variations throughout the material. Color matching is not guaranteed between dye lots and inconsistencies may be more prominent in volumes that exceed the normal commercial standard.

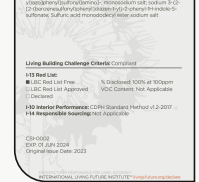
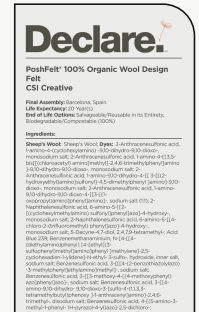
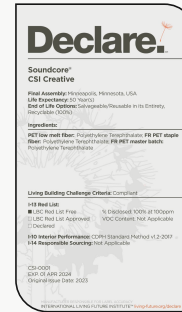

*Approximate. NRC rating may vary due to product dimensions and spacing.

Dimensions

Standard Unit Dimensions

Typical ranges for height and width.

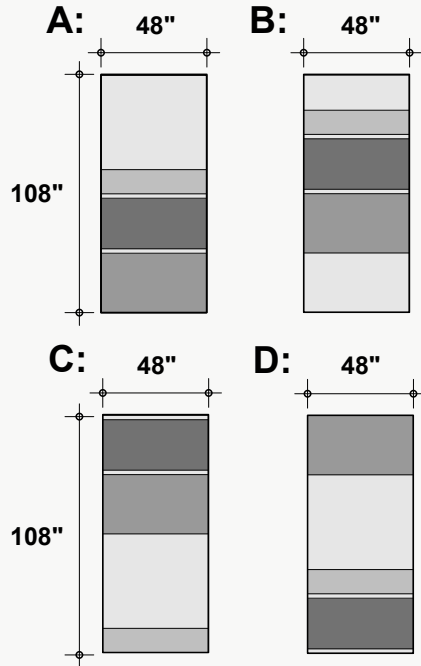

Custom Opportunity

Product dimensions can be manipulated in order to fit your design aesthetic and site conditions.

Standard Unit Thicknesses

Thickness is dependent on material layer selection.

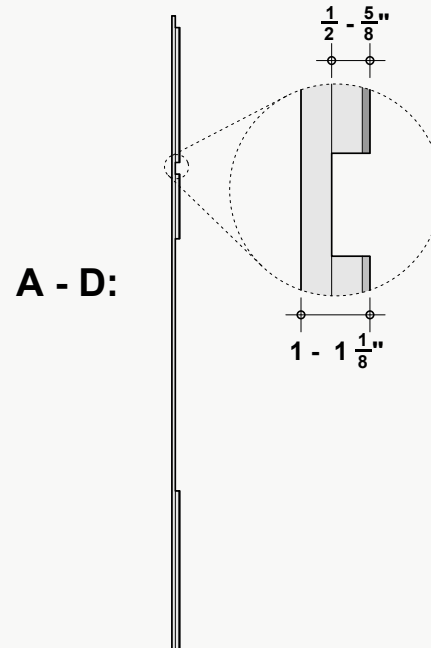

Product Details

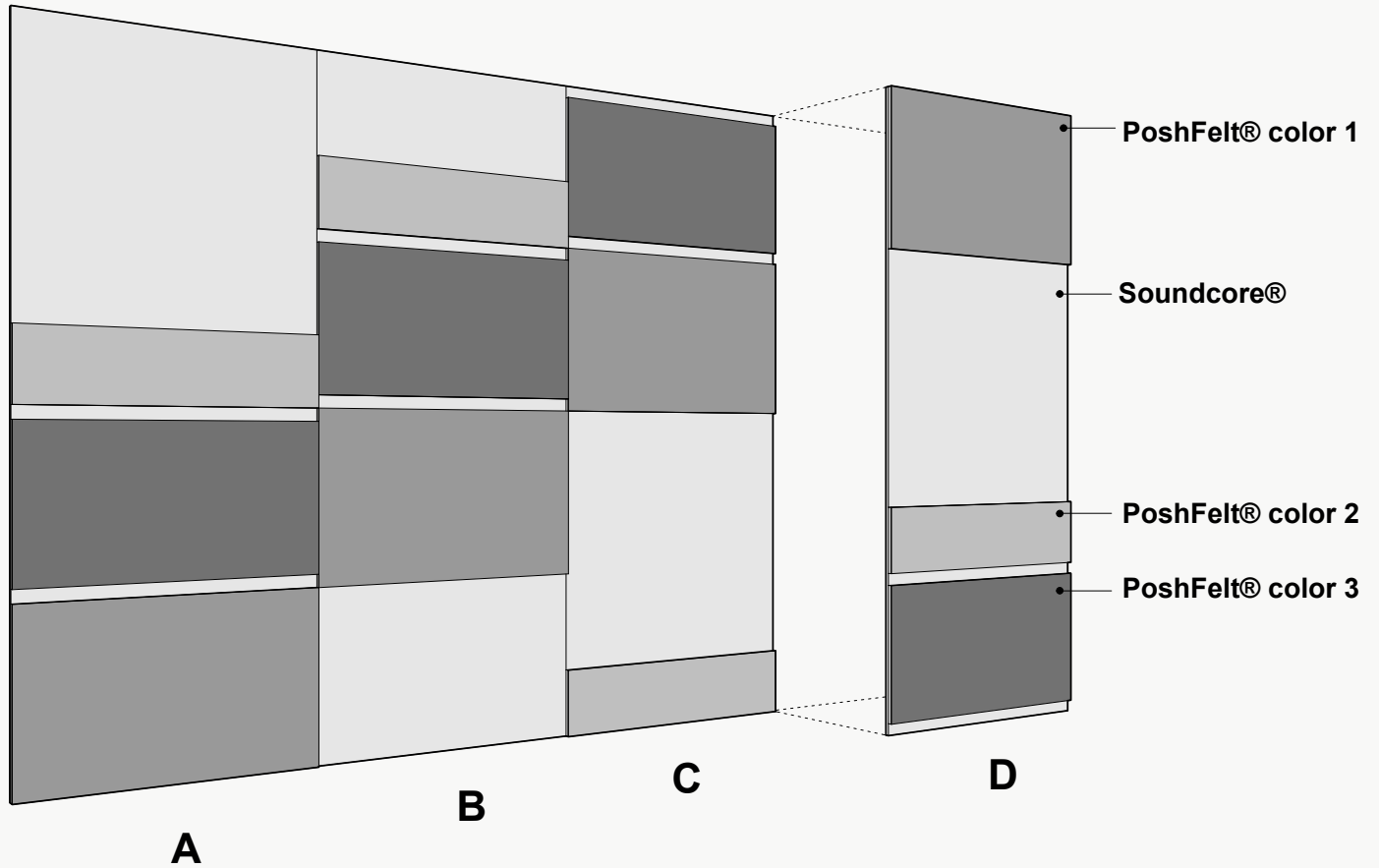

Configuration Options

The layouts shown are a summation of individual units. Individual units may be assembled in various arrangements to dictate the larger design. Configurations shown are suggested, but can be rearranged to achieve a custom layout.

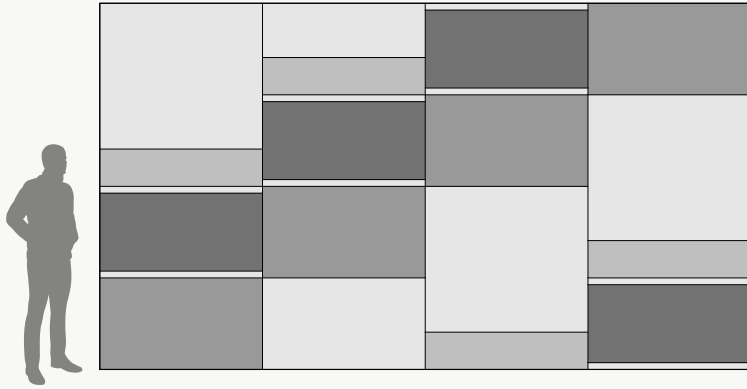

Patterned

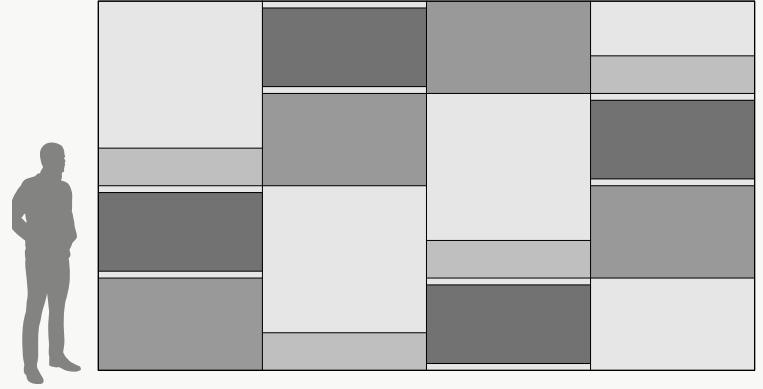

Random

Installation Options*

All products and installation methods can be **customized** to meet the unique requirements of your space.

Adhesive Direct Advantages

Attachment solution using an adhesive to apply directly to an existing surface or substrate.

- + Fastest installation time
- + No gap between target surface and product
- + Lowest profile installation option
- + Easiest to install
- + Most versatile installation option

Available methods: Construction Adhesive, Peel & Stick, Custom

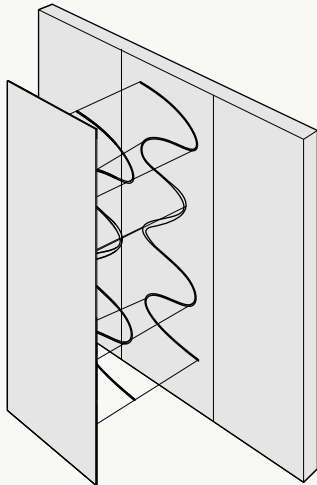

Mechanical Direct Advantages

Attachment solution using physical hardware to attach to an existing surface or substrate.

- + No clamping or dry time necessary
- + Easy to remove and does not damage the substrate when removed
- + Most appropriate installation solution for heavier products
- + Provides an opportunity for an air gap, which can increase the acoustic value of a product

Available methods: Z-Clips, Panel Clips, Standoffs, Screw & Washer, Magnet, Custom

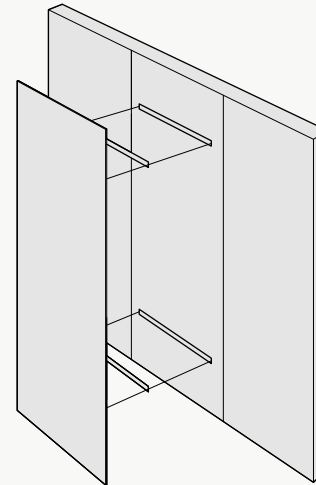

*Not all listed attachment methods may be applicable to this product.

Material Layers

Soundcore®

Our recycled PET felt creates an acoustic barrier, defending against wandering white noise and irritating echoes.

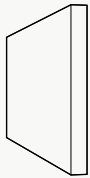

Single Layer
½" Thickness

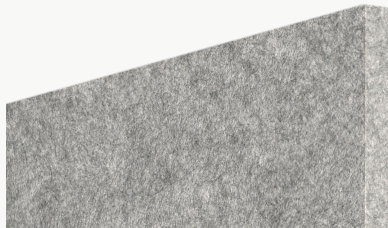

Soundcore® Wood Textures

Soundcore® wood textures provide the natural aesthetic of wood while maintaining all the acoustic benefits of PET felt. Custom texture opportunities are also available upon request.

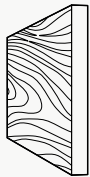

Single Layer
½" Thickness



PoshFelt® Exposed Edge

100% organic, natural wool design felt brings out the best experience in your space with color, comfort, and simple sustainability. Exposed edge products leave the Soundcore® layer uncovered, allowing for unique color combinations.

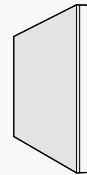

Multi-Layer
Adds ⅛"-¼" to Material Thickness



PoshFelt® | 3mm Thickness



PSH005
Black Beauty

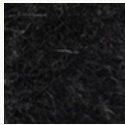

PSH161
Black Swan



PSH266
Koala

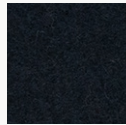

PSH627
Blackberry



PSH265
Slag



PSH513
Gravel



PSH001
Gray Matter

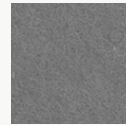

PSH004
Porpoise

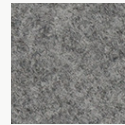

PSH176
Warmstone

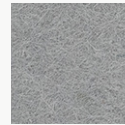

PSH512
Ash Plume



PSH545
Henna

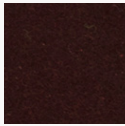

PSH249
French Press



PSH146
Auburn



PSH521
Cocoa

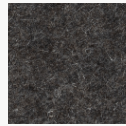

PSH179
Arctic Seal

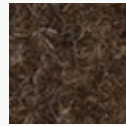

PSH180
Iron Ore



PSH505
Garrigue

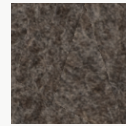

PSH003
Otter



PSH520
Silt

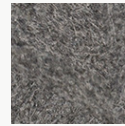

PSH002
Heather



PSH504
Earth



PSH255
Tropical Walnut



PSH269
Canyon



PSH253
Toffee



PSH602
Cafe



PSH281
Great Plains



PSH503
Savanna



PSH509
Cairo



PSH621
Pan

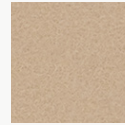

PSH291
Gobi

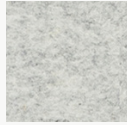

PSH299
Mountain Breeze



PSH300
Crevasse

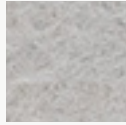

PSH625
Silver Chain

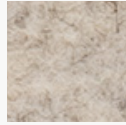

PSH515
Blizzard

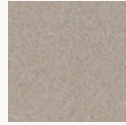

PSH127
Mocha

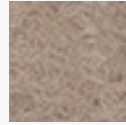

PSH635
Eggshell



PSH178
Fawn



PSH175
Dovetail

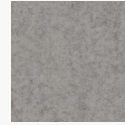

PSH624
Dapple Gray

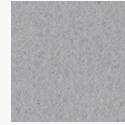

PSH609
Cityscape

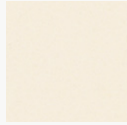

PSH118
Ivory Lace

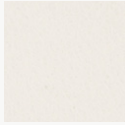

PSH174
Cotton



PSH293
Pound Cake



PSH519*
Cupcake



PSH630
Sand Dune

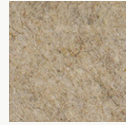

PSH006
Shiitake

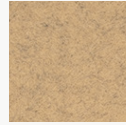

PSH301
Tumbleweed



PSH637
Chiffon



PSH304
Sugar Cookie



PSH541
Banana Bread

*6-roll MOQ

PoshFelt® | 3mm Thickness



PSH215
Raincoat



PSH622
Corn



PSH295
Sunrise Peach



PSH507
Hive



PSH015
Honey



PSH305
Dandelion

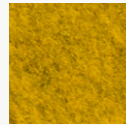

PSH216
Lion's Den



PSH634
Amber



PSH261
Pale Ale



PSH638
Sunflower



PSH610
Coral



PSH632
Peach



PSH218
Citrus



PSH532
Harvest



PSH014
Knockout Orange

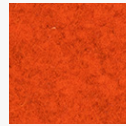

PSH307
Orange Nectar



PSH633
Clementine



PSH245
Fire Agate



PSH525
Olympus



PSH640
Rusted

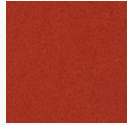

PSH139
Cayenne



PSH535
Guppy

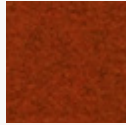

PSH528
Ferrous



PSH296
Paprika



PSH530
Hot Iron

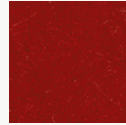

PSH537
Cardinal



PSH008
Bonfire



PSH308
Scarlet



PSH009
Poinsettia



PSH527
Red Velvet



PSH137
Passion Flower



PSH273
Ultraviolet



PSH649
Pomegranate



PSH617
Evening Gown

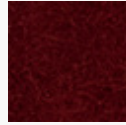

PSH540
Devil's Food

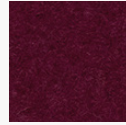

PSH644
Maroon

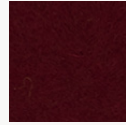

PSH210
Sangria

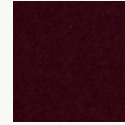

PSH211
Cherry Chutney

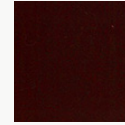

PSH212
Vino

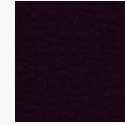

PSH514
Red Wine



PSH272
Hotwire



PSH302
Heather Pink



PSH202
Crush



PSH647
Eden Rose

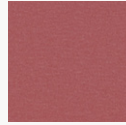

PSH643
Rhododendron

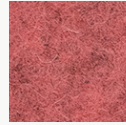

PSH560
Schiava



PSH559
Monroe

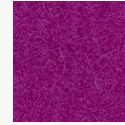

PSH544
Dragonfruit



PSH309
Allium

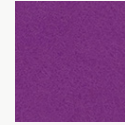

PSH205
Mulberry

PoshFelt® | 3mm Thickness

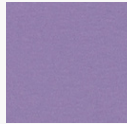

PSH612
Lilac



PSH646
Lupine



PSH274
Amethyst



PSH523
Violet Sky



PSH546
Tyrian Plum



PSH142
Plum Purple



PSH286
Viper

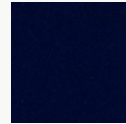

PSH241
Tranquilo

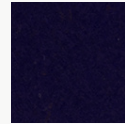

PSH550
Mariana

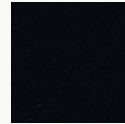

PSH277
Shade

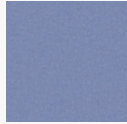

PSH615
Imagine

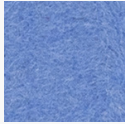

PSH510
Ozone



PSH237
Hotspring



PSH508
Oahu

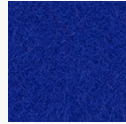

PSH548
Ultramarine

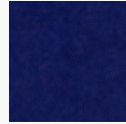

PSH160
Admiral Blue



PSH239
Speckled Navy



PSH561
Neptune



PSH645
Space



PSH614
Blueberry



PSH502
Pacific



PSH238
Cobalt



PSH152
Blue Nile



PSH616
Fountain

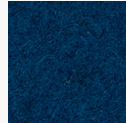

PSH516
Actun



PSH511
Lagoon

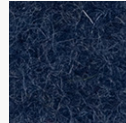

PSH636
Navy Blue

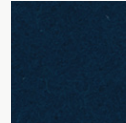

PSH260
Twilight

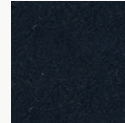

PSH310
Deep Royal



PSH278
Squid Ink



PSH606
Midday



PSH306
Swell

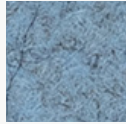

PSH608
Diamond Dust

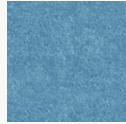

PSH605
Meander



PSH628
Cozumel



PSH016
Freshwater



PSH650
Waterfall



PSH149
Jamaica Bay

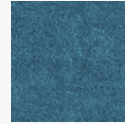

PSH604
Atlantic

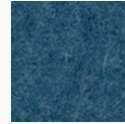

PSH648
Aegean

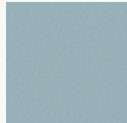

PSH639
Glacier

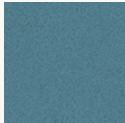

PSH287
Sea Breeze

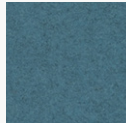

PSH631
Adriatic

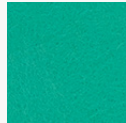

PSH232
Seaglass



PSH629
Robin's Egg

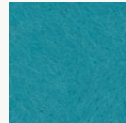

PSH517
Sky Stone

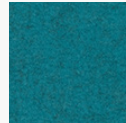

PSH552
Cancun

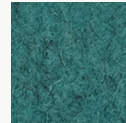

PSH642
Blue Spruce

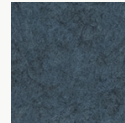

PSH623
Steel Gray

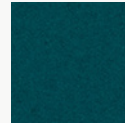

PSH564
Jazz

PoshFelt® | 3mm Thickness



PSH618
Iguana



PSH641
Basil

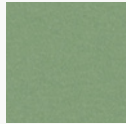

PSH619
Springtime

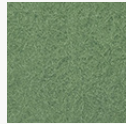

PSH213
Meadow

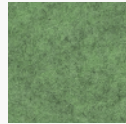

PSH303
Feather Moss



PSH226
Grove



PSH298
Peacock



PSH234
Ocean Trench



PSH311
Emerald



PSH626
Evergreen



PSH225
Everglade



PSH164
Fresh Lime



PSH554
Cyber Green



PSH555
Hemlocks



PSH012
Shamrock

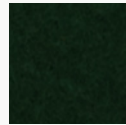

PSH228
Forest Haze

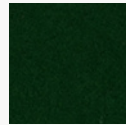

PSH227
Succulent



PSH563
Rosemary

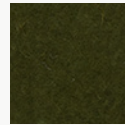

PSH501
Mire



PSH506
Bracken

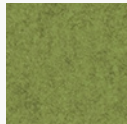

PSH562
Aurora

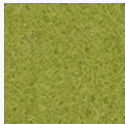

PSH556
Avocado

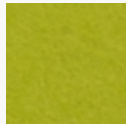

PSH013
Parakeet

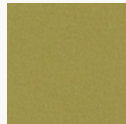

PSH611
Haybale

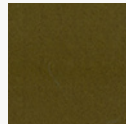

PSH312
Safari

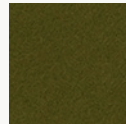

PSH230
Camouflage

Soundcore® | 1/2" Thickness

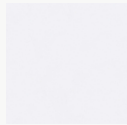

SND019
Linen

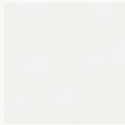

SND037
Paper

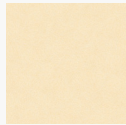

SND134
Oat



SND135
Vanilla Bean



SND105
Sand Dollar



SND109
Macadamia



SND111
Lanai



SND130
Buckskin

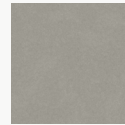

SND131
Abalone

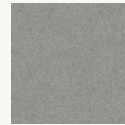

SND125
Chinchilla



SND118
Anchor



SND126
Wolfhound



SND110
Starry Night



SND102
Morning Fog

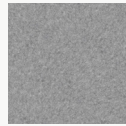

SND114
Lunar Dust

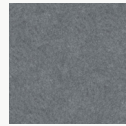

SND034
Granite Peak

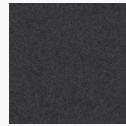

SND132
Cast Iron

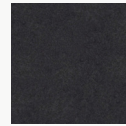

SND103
Storm Cloud



SND038
Inkwell



SND122
Briquette



SND127
Burnt Toast



SND108
Ablaze



SND104
Pumpkin



SND141
Terracotta



SND106
Goldfinch



SND107
Grasshopper



SND113
Gruner



SND143
Olive

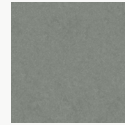

SND129
Dried Thyme

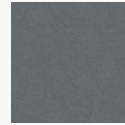

SND115
Mako



SND136
Clover



SND138
Fern



SND137
Cove



SND112
Tulum



SND139
Tidal



SND121
Apatite

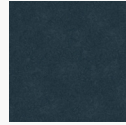

SND123
Chrysocolla



SND117
Serene



SND124
Ice Floe

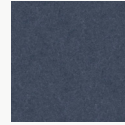

SND128
Arctic Ocean

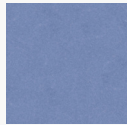

SND042
Denim

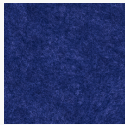

SND101
Commodore



SND140
Marine



SND133
Galactic



SND142
Fig

Soundcore® Wood Textures | 1/2" Thickness



SND716
Dark Teak



SND792
Dark Oak



SND715
Dark Cherry



SND793
Vintage Maple



SND794
Warm Teak



SND714
English Walnut



SND713
Honey Walnut



SND717
Warm Oak

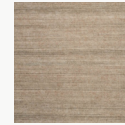

SND790
Natural Teak

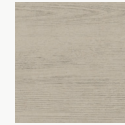

SND712
Natural Spruce



SND711
Bleached Cherry



SND795
Light Teak



SND709
White Maple



SND791
Gray Oak



SND710
Gray Teak