



Why WoodLite?

WoodLite® features wood-look felted acoustic material made from our Soundcore® PET-felt. This collection offers an innovative alternative to traditional wood-based installations, while maintaining the emotional resonance of natural wood in indoor environments.



Lower Cost

- + Cheaper base product
- + Faster, less specialized install



Powerful Acoustics

- + Inherently sound absorbing
- + No unsightly perforated surfaces



Sustainability

- + Made from 60% post-consumer recycled content
- + 100% recyclable

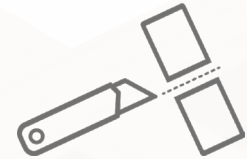

Renovation

- + Field trimmed using utility knife and straight edge
- + Cutting creates no noise or dust
- + Lightweight products are easier to manipulate

Dimensions

Standard Unit Dimensions

Typical ranges for height and width.

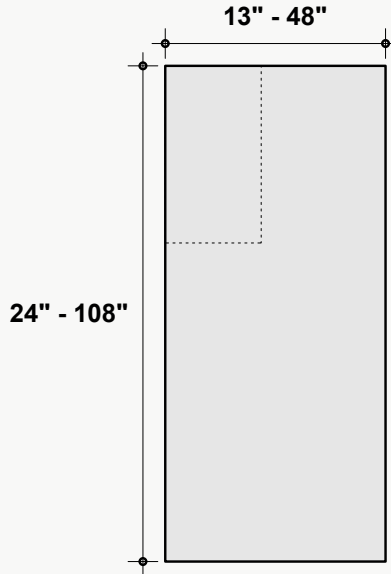

Custom Opportunity

Product dimensions can be manipulated in order to fit your design aesthetic and site conditions.

Standard Unit Thicknesses

Thickness is dependent on material layer selection.

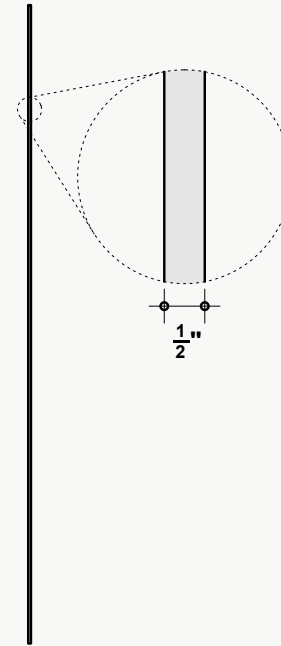

Product Details

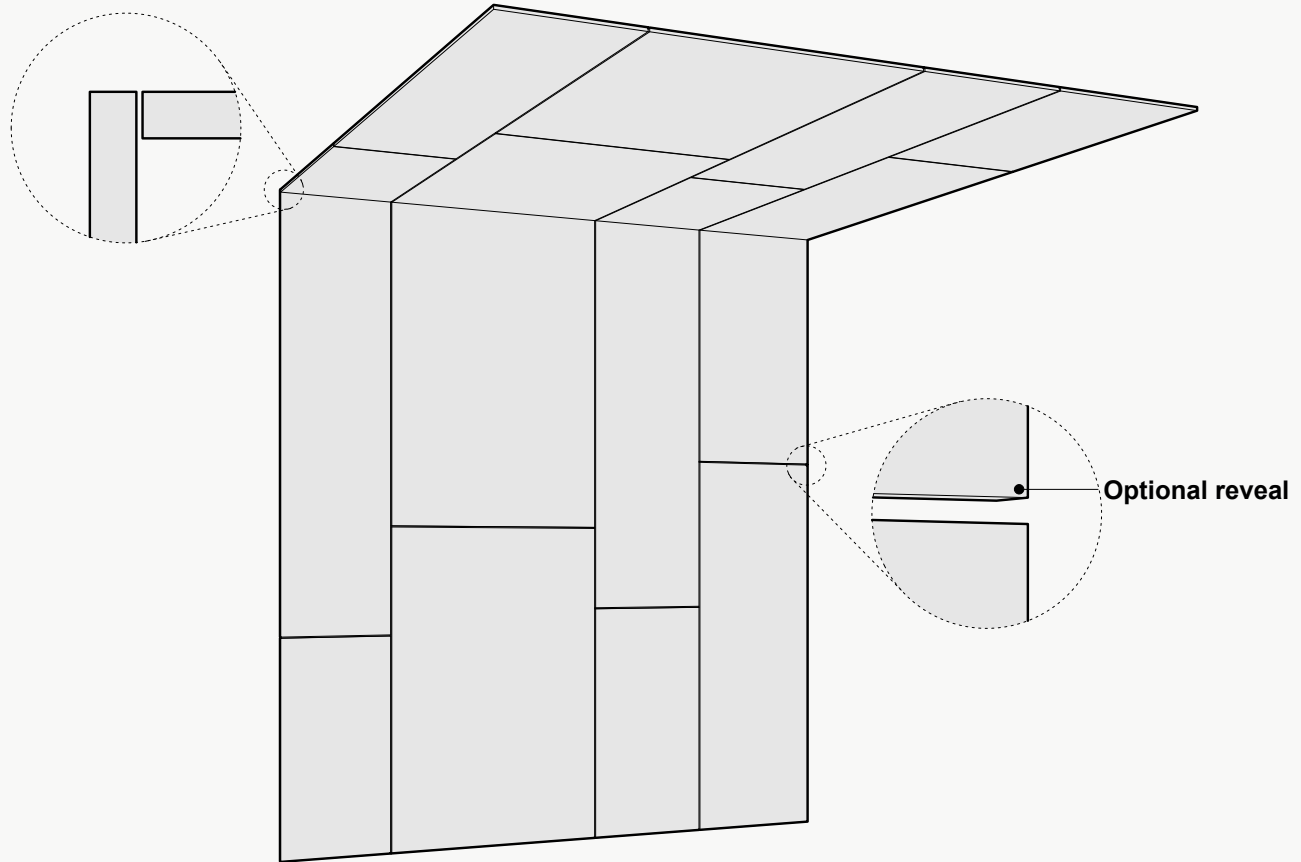

Configuration Options

The layouts shown are a summation of individual units. Individual units may be assembled in various arrangements to dictate the larger design. Configurations shown are suggested, but can be rearranged to achieve a custom layout.

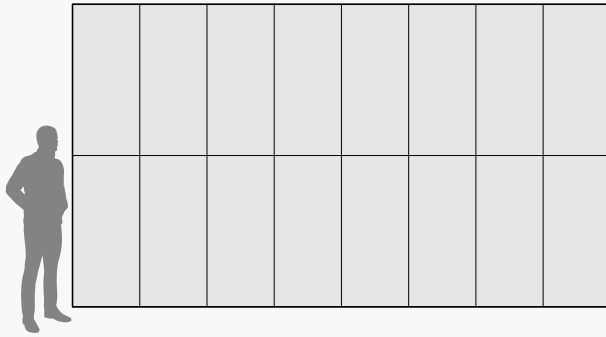

Uniform

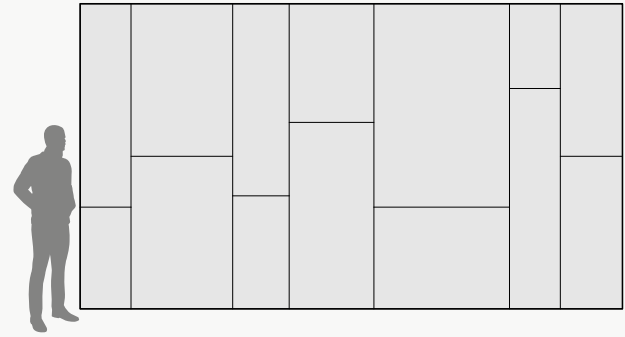

Staggered

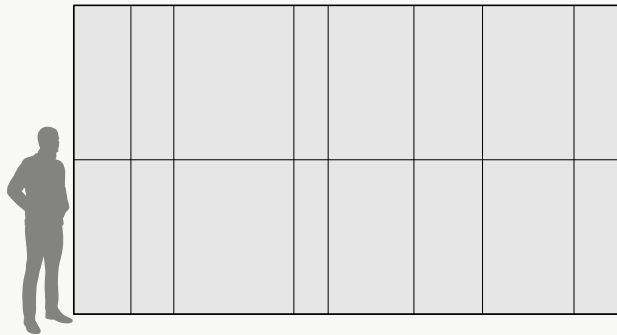

Aligned

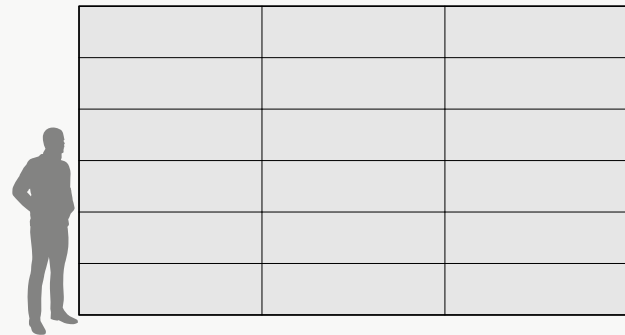

Horizontal

Installation Options*

All products and installation methods can be **customized** to meet the unique requirements of your space.

Adhesive Direct Advantages

Attachment solution using an adhesive to apply directly to an existing surface or substrate.

- + Fastest installation time
- + No gap between target surface and product
- + Lowest profile installation option
- + Easiest to install
- + Most versatile installation option

Available methods: Construction Adhesive, Peel & Stick, Custom

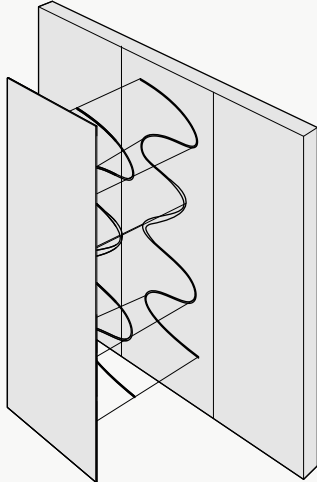

Mechanical Direct Advantages

Attachment solution using physical hardware to attach to an existing surface or substrate.

- + No clamping or dry time necessary
- + Easy to remove and does not damage the substrate when removed
- + Most appropriate installation solution for heavier products
- + Provides an opportunity for an air gap, which can increase the acoustic value of a product

Available methods: Z-Clips, Panel Clips, Standoffs, Screw & Washer, Magnet, Custom

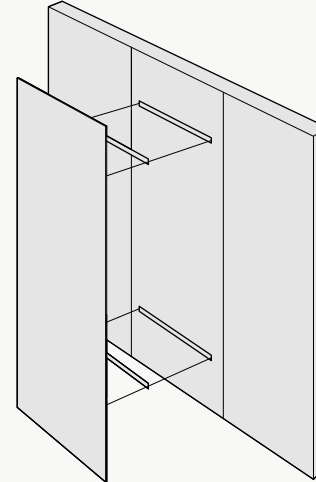

*Not all listed attachment methods may be applicable to this product.

Material Layers

Soundcore® Wood Textures

Soundcore® wood textures provide the natural aesthetic of wood while maintaining all the acoustic benefits of PET felt. Custom texture opportunities are also available upon request.



Single Layer
½" Thickness



Soundcore® Wood Textures | 1/2" Thickness



SND716
Dark Teak



SND792
Dark Oak



SND715
Dark Cherry



SND793
Vintage Maple

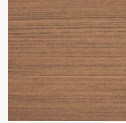

SND794
Warm Teak

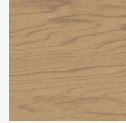

SND714
English Walnut

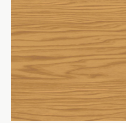

SND713
Honey Walnut

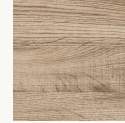

SND717
Warm Oak

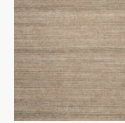

SND790
Natural Teak

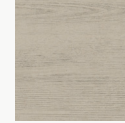

SND712
Natural Spruce



SND796
Vintage Cherry



SND711
Bleached Cherry



SND795
Light Teak



SND709
White Maple



SND791
Gray Oak

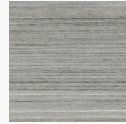

SND710
Gray Teak