



CSI EARTH BREATHE

BIO-BTH-001

Product Specifications

| | |
|---------------------|--|
| Product Name | Breathe |
| Product ID | BIO-BTH-001 |
| Acoustics | 0.75 NRC* |
| Lead Time | Lead time is dependent on project size. Contact us for more information. |
| Durability | Contract |

| | |
|---------------------|--|
| Warranty | Comes with industry-leading standard warranty. |
| Flammability | ASTM E84: Class A |
| Custom | Custom colors and manufacturing services available. Additional charges and lead times may apply. |
| Maintenance | Vacuum occasionally to remove airborne dust or debris. Mild detergents or soaps may be used to remove stains. For detailed care instructions, refer to the CSI Creative Maintenance Information document. |

Material Specifications

| | | |
|----------------------|---|--|
| | Soundcore® | PoshFelt® |
| Content | Recycled PET acoustic felt | 100% Merino or Karakul wool acoustic felt |
| Weathering | Colorfast, non-deteriorating, non-hygroscopic | Colorfast, non-deteriorating, non-woven, moisture resistant |
| Environmental | Recycled PET acoustic felt is 60% post-consumer recycled content and is 100% recyclable. Contributes points toward LEED v4, CDPH v1.2, VOC free, non-toxic, non-allergenic, anti-microbial - does not attract mold and mildew. Compliant with Living Building Challenge criteria & DECLARE Red List Free. | 100% organic wool design felt is a rapidly renewable resource and is 100% biodegradable/compostable. Contributes points toward LEED v4, CDPH v1.2, VOC free, no chemical irritants, no formaldehyde, and is free of other harmful substances. Compliant with Living Building Challenge criteria & DECLARE Red List Free. |
| Variation | PET felt panels are created through a manufacturing process known as 'felting'. This process results in a heathered appearance. Multiple color tones may appear in the same panel. Slight color variations should be expected. | Due to its 100% natural origin, the raw fibers of wool felt contain inclusions and color variations throughout the material. Color matching is not guaranteed between dye lots and inconsistencies may be more prominent in volumes that exceed the normal commercial standard. |

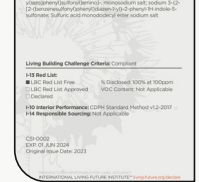
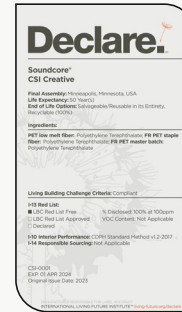

*Approximate. NRC rating may vary due to product dimensions and spacing.

Dimensions

Standard Unit Dimensions

Typical ranges for height and width.

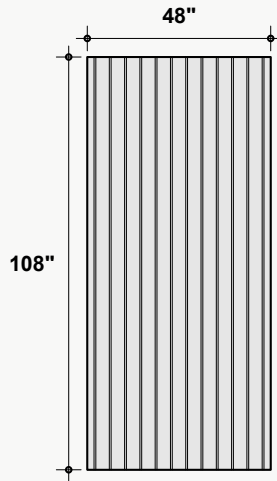

Custom Opportunity

Product dimensions can be manipulated in order to fit your design aesthetic and site conditions.

Standard Unit Thicknesses

Thickness is independent of material layer selection.

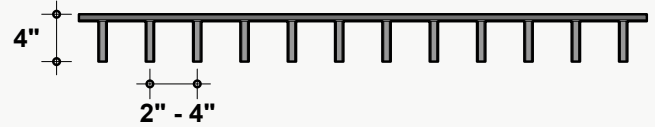

Product Details

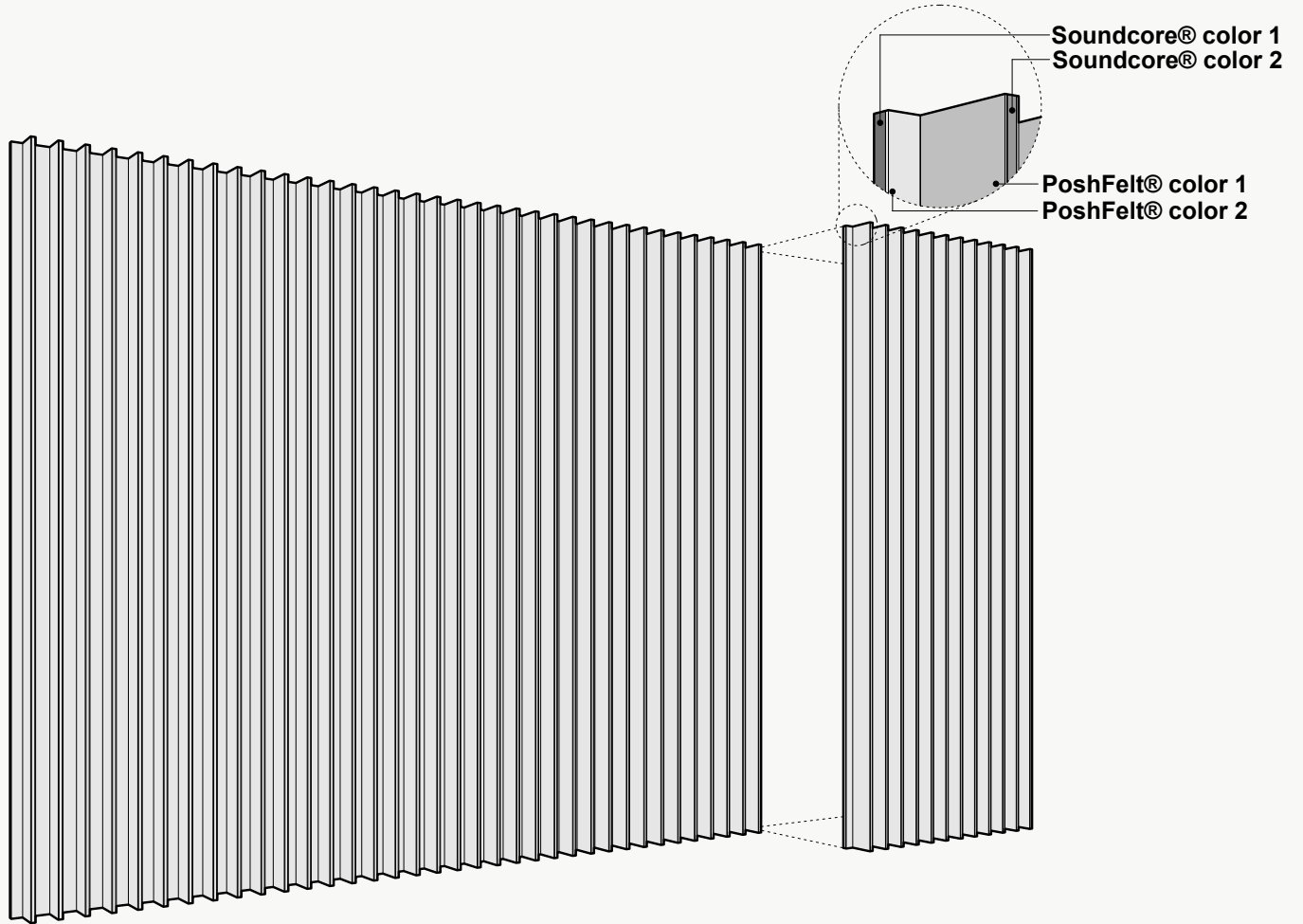

Custom signage available

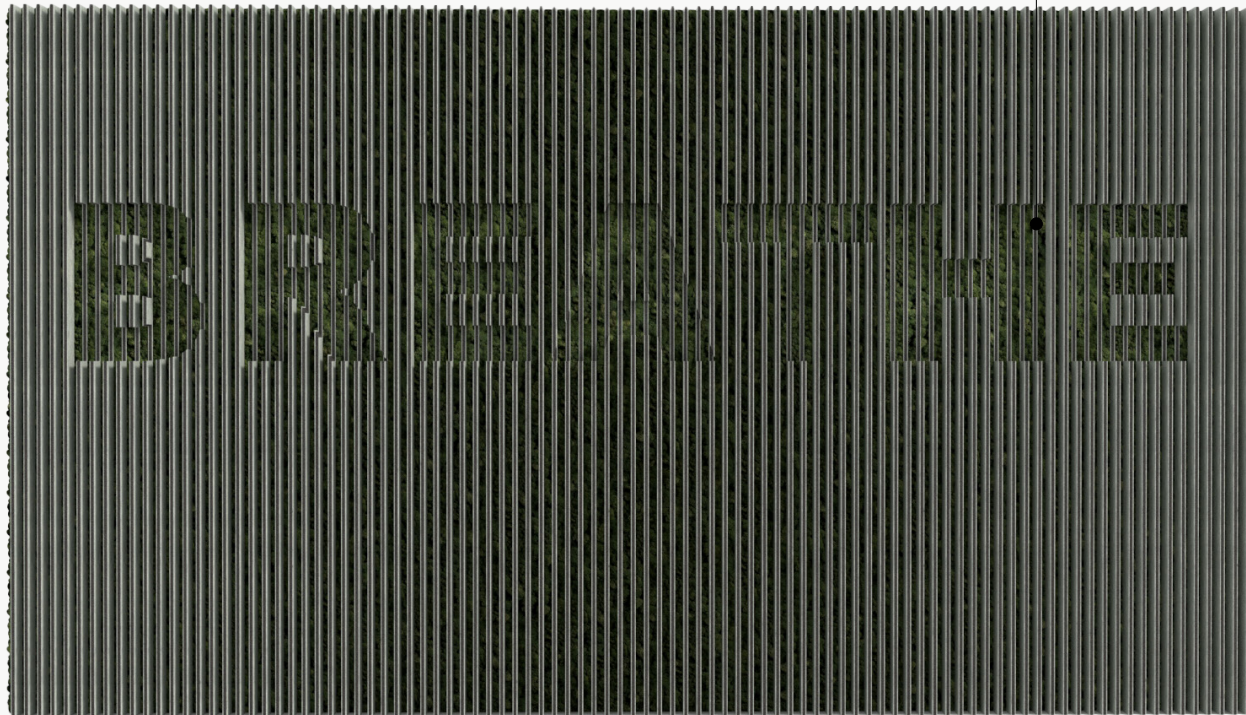

Moss Specs

ThermaLeaf® by Plantscape Commercial Silk

A trademarked brand of artificial foliage whereby the fire retardant chemicals are infused into the raw materials at a molecular level during the manufacturing process, creating the safest self-extinguishing foliage in the industry today.

- + ASTM E84-95 Class A Fired Rated
- + Injected, non-topical treatment will not wash or wear off
- + Long lasting, consistent fire protection

Available Colors

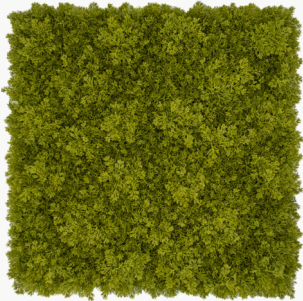

Light Green
MRD#+L22MLG

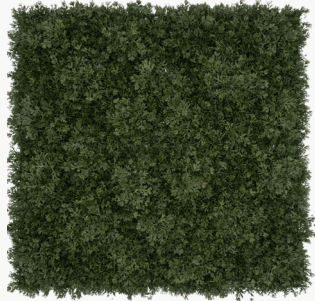

Dark Green
MRD#+L22MDG

Installation Options*

All products and installation methods can be **customized** to meet the unique requirements of your space.

Adhesive Direct Advantages

Attachment solution using an adhesive to apply directly to an existing surface or substrate.

- + Fastest installation time
- + No gap between target surface and product
- + Lowest profile installation option
- + Easiest to install
- + Most versatile installation option

Available methods: Construction Adhesive, Peel & Stick, Custom

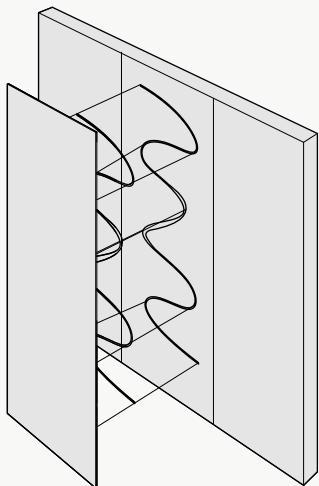

Mechanical Direct Advantages

Attachment solution using physical hardware to attach to an existing surface or substrate.

- + No clamping or dry time necessary
- + Easy to remove and does not damage the substrate when removed
- + Most appropriate installation solution for heavier products
- + Provides an opportunity for an air gap, which can increase the acoustic value of a product

Available methods: Z-Clips, Panel Clips, Standoffs, Screw & Washer, Magnet, Custom

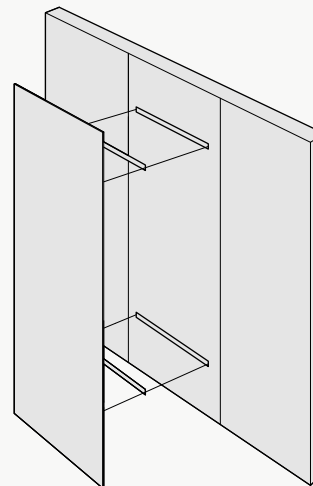

*Not all listed attachment methods may be applicable to this product.

Material Layers

Soundcore®

Our recycled PET felt creates an acoustic barrier, defending against wandering white noise and irritating echoes.

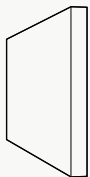

Single Layer
½" Thickness

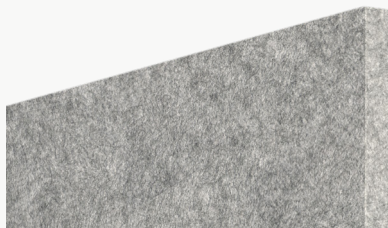

PoshFelt® Exposed Edge

100% organic, natural wool design felt brings out the best experience in your space with color, comfort, and simple sustainability. Exposed edge products leave the Soundcore® layer uncovered, allowing for unique color combinations.

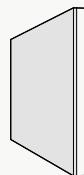

Multi-Layer
Adds ⅛"-¼" to Material Thickness



Soundcore® Wood Textures



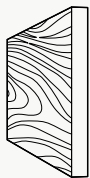







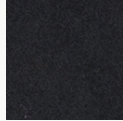

Soundcore® wood textures provide the natural aesthetic of wood while maintaining all the acoustic benefits of PET felt. Custom texture opportunities are also available upon request.

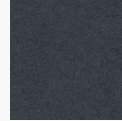
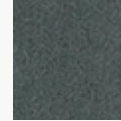
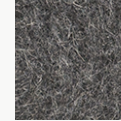
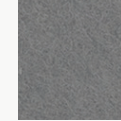
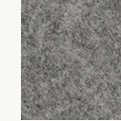
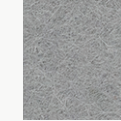
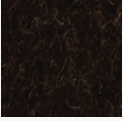
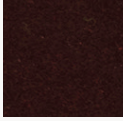
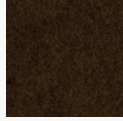
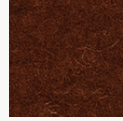
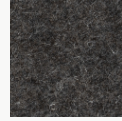
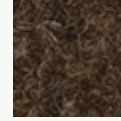

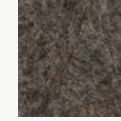
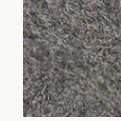
Single Layer
½" Thickness

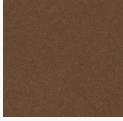

PoshFelt® | 3mm Thickness

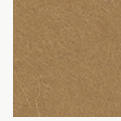
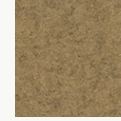
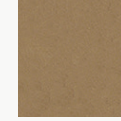
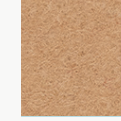
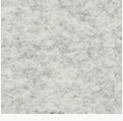
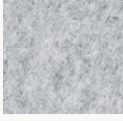
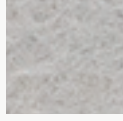
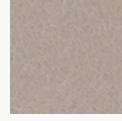
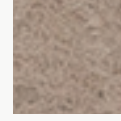
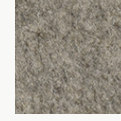
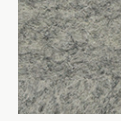
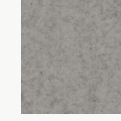
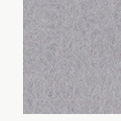
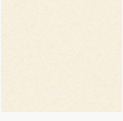
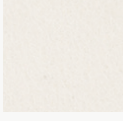
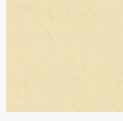
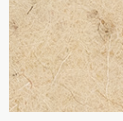
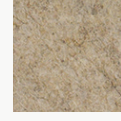
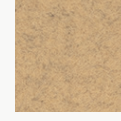
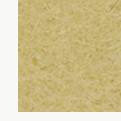
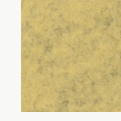
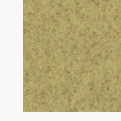

















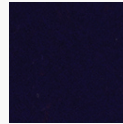

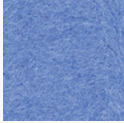







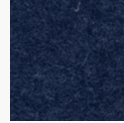





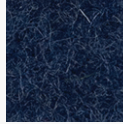

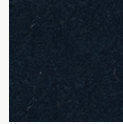









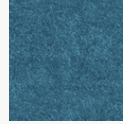

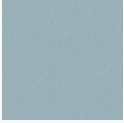
| | | | | | | | | | |
|--|---|---|---|---|---|---|---|---|---|
|  |  |  |  |  |  |  |  |  |  |
| PSH005 Black Beauty | PSH161 Black Swan | PSH266 Koala | PSH627 Blackberry | PSH265 Slag | PSH513 Gravel | PSH001 Gray Matter | PSH004 Porpoise | PSH176 Warmstone | PSH512 Ash Plume |
|  |  |  |  |  |  |  |  |  |  |
| PSH545 Henna | PSH249 French Press | PSH146 Auburn | PSH521 Cocoa | PSH179 Arctic Seal | PSH180 Iron Ore | PSH505 Garrigue | PSH003 Otter | PSH520 Silt | PSH002 Heather |
|  |  |  |  |  |  |  |  |  |  |
| PSH504 Earth | PSH255 Tropical Walnut | PSH269 Canyon | PSH253 Toffee | PSH602 Cafe | PSH281 Great Plains | PSH503 Savanna | PSH509 Cairo | PSH621 Pan | PSH291 Gobi |
|  |  |  |  |  |  |  |  |  |  |
| PSH299 Mountain Breeze | PSH300 Crevasse | PSH625 Silver Chain | PSH515 Blizzard | PSH127 Mocha | PSH635 Eggshell | PSH178 Fawn | PSH175 Dovetail | PSH624 Dapple Gray | PSH609 Cityscape |
|  |  |  |  |  |  |  |  |  |  |
| PSH118 Ivory Lace | PSH174 Cotton | PSH293 Pound Cake | PSH519* Cupcake | PSH630 Sand Dune | PSH006 Shiitake | PSH301 Tumbleweed | PSH637 Chiffon | PSH304 Sugar Cookie | PSH541 Banana Bread |

*6-roll MOQ

PoshFelt® | 3mm Thickness

| | | | | | | | | | |
|--|---|---|---|---|---|---|---|---|---|
|  |  |  |  |  |  |  |  |  |  |
| PSH215 Raincoat | PSH622 Corn | PSH295 Sunrise Peach | PSH507 Hive | PSH015 Honey | PSH305 Dandelion | PSH216 Lion's Den | PSH634 Amber | PSH261 Pale Ale | PSH638 Sunflower |
|  |  |  |  |  |  |  |  |  |  |
| PSH610 Coral | PSH632 Peach | PSH218 Citrus | PSH532 Harvest | PSH014 Knockout Orange | PSH307 Orange Nectar | PSH633 Clementine | PSH245 Fire Agate | PSH525 Olympus | PSH640 Rusted |
|  |  |  |  |  |  |  |  |  |  |
| PSH139 Cayenne | PSH535 Guppy | PSH528 Ferrous | PSH296 Paprika | PSH530 Hot Iron | PSH537 Cardinal | PSH008 Bonfire | PSH308 Scarlet | PSH009 Poinsettia | PSH527 Red Velvet |
|  |  |  |  |  |  |  |  |  |  |
| PSH137 Passion Flower | PSH273 Ultraviolet | PSH649 Pomegranate | PSH617 Evening Gown | PSH540 Devil's Food | PSH644 Maroon | PSH210 Sangria | PSH211 Cherry Chutney | PSH212 Vino | PSH514 Red Wine |
|  |  |  |  |  |  |  |  |  |  |
| PSH272 Hotwire | PSH302 Heather Pink | PSH202 Crush | PSH647 Eden Rose | PSH643 Rhododendron | PSH560 Schiava | PSH559 Monroe | PSH544 Dragonfruit | PSH309 Allium | PSH205 Mulberry |

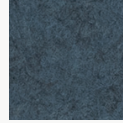
PoshFelt® | 3mm Thickness

| | | | | | | | | | |
|--|---|---|---|---|--|---|---|---|---|
|  |  |  |  |  |  |  |  |  |  |
| PSH612 Lilac | PSH646 Lupine | PSH274 Amethyst | PSH523 Violet Sky | PSH546 Tyrian Plum | PSH142 Plum Purple | PSH286 Viper | PSH241 Tranquilo | PSH550 Mariana | PSH277 Shade |
|  |  |  |  |  |  |  |  |  |  |
| PSH615 Imagine | PSH510 Ozone | PSH237 Hotspring | PSH508 Oahu | PSH548 Ultramarine | PSH160 Admiral Blue | PSH239 Speckled Navy | PSH561 Neptune | PSH645 Space | PSH614 Blueberry |
|  |  |  |  |  |  |  |  |  |  |
| PSH502 Pacific | PSH238 Cobalt | PSH152 Blue Nile | PSH616 Fountain | PSH516 Actun | PSH511 Lagoon | PSH636 Navy Blue | PSH260 Twilight | PSH310 Deep Royal | PSH278 Squid Ink |
|  |  |  |  |  |  |  |  |  |  |
| PSH606 Midday | PSH306 Swell | PSH608 Diamond Dust | PSH605 Meander | PSH628 Cozumel | PSH016 Freshwater | PSH650 Waterfall | PSH149 Jamaica Bay | PSH604 Atlantic | PSH648 Aegean |
|  |  |  |  |  |  |  |  |  |  |
| PSH639 Glacier | PSH287 Sea Breeze | PSH631 Adriatic | PSH232 Seaglass | PSH629 Robin's Egg | PSH517 Sky Stone | PSH552 Cancun | PSH642 Blue Spruce | PSH623 Steel Gray | PSH564 Jazz |

PoshFelt® | 3mm Thickness



PSH618
Iguana



PSH641
Basil



PSH619
Springtime

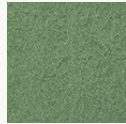

PSH213
Meadow

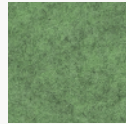

PSH303
Feather Moss

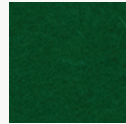

PSH226
Grove



PSH298
Peacock



PSH234
Ocean Trench



PSH311
Emerald

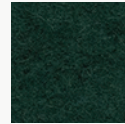

PSH626
Evergreen



PSH225
Everglade



PSH164
Fresh Lime



PSH554
Cyber Green



PSH555
Hemlocks



PSH012
Shamrock



PSH228
Forest Haze



PSH227
Succulent



PSH563
Rosemary

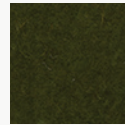

PSH501
Mire



PSH506
Bracken

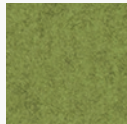

PSH562
Aurora



PSH556
Avocado



PSH013
Parakeet



PSH611
Haybale

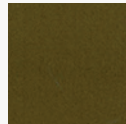

PSH312
Safari

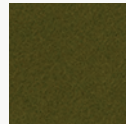

PSH230
Camouflage

Soundcore® | 1/2" Thickness

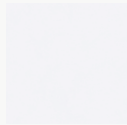

SND019
Linen

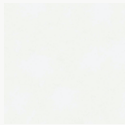

SND037
Paper



SND134
Oat



SND135
Vanilla Bean



SND105
Sand Dollar



SND109
Macadamia



SND111
Lanai



SND130
Buckskin



SND131
Abalone



SND125
Chinchilla



SND118
Anchor

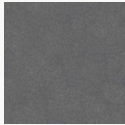

SND126
Wolfhound



SND110
Starry Night

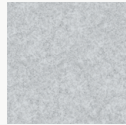

SND102
Morning Fog

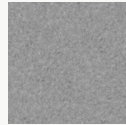

SND114
Lunar Dust

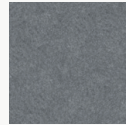

SND034
Granite Peak

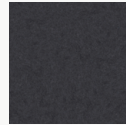

SND132
Cast Iron



SND103
Storm Cloud



SND038
Inkwell



SND122
Briquette



SND127
Burnt Toast



SND108
Ablaze



SND104
Pumpkin



SND106
Goldfinch



SND113
Gruner

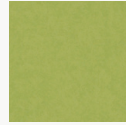

SND107
Grasshopper



SND136
Clover

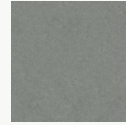

SND129
Dried Thyme

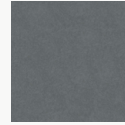

SND115
Mako

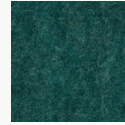

SND137
Cove



SND112
Tulum



SND121
Apatite



SND123
Chrysocolla



SND117
Serene



SND124
Ice Floe



SND128
Arctic Ocean

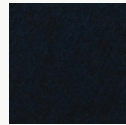

SND133
Galactic



SND116
Blue Marlin

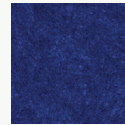

SND101
Commodore



SND042
Denim

Soundcore® Wood Textures | 1/2" Thickness



SND716
Dark Teak



SND792
Dark Oak



SND715
Dark Cherry



SND793
Vintage Maple



SND794
Warm Teak



SND714
English Walnut



SND713
Honey Walnut



SND717
Warm Oak



SND790
Natural Teak

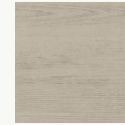

SND712
Natural Spruce



SND711
Bleached Cherry



SND795
Light Teak



SND709
White Maple



SND791
Gray Oak

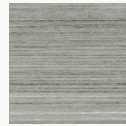

SND710
Gray Teak