

# Product Specifications

<b>Product Name</b>	Curled Surfaces 002
<b>Product ID</b>	SUR-CRL-002
<b>Acoustics</b>	0.80 NRC*
<b>Lead Time</b>	Lead time is dependent on project size. Contact us for more information.
<b>Durability</b>	Contract

<b>Warranty</b>	Comes with industry-leading standard warranty.
<b>Flammability</b>	ASTM E84: Class A
<b>Custom</b>	Custom colors and manufacturing services available. Additional charges and lead times may apply.
<b>Maintenance</b>	Vacuum occasionally to remove airborne dust or debris. Mild detergents or soaps may be used to remove stains. For detailed care instructions, refer to the <b>CSI Creative Maintenance Information</b> document.

# Material Specifications

	<b>Soundcore®</b>	<b>PoshFelt®</b>
<b>Content</b>	Recycled PET acoustic felt	100% Merino or Karakul wool acoustic felt
<b>Weathering</b>	Colorfast, non-deteriorating, non-hygroscopic	Colorfast, non-deteriorating, non-woven, moisture resistant
<b>Environmental</b>	Recycled PET acoustic felt is 60% post-consumer recycled content and is 100% recyclable. Contributes points toward LEED v4, CDPH v1.2, VOC free, non-toxic, non-allergenic, anti-microbial - does not attract mold and mildew. Compliant with Living Building Challenge criteria & DECLARE Red List Free.	100% organic wool design felt is a rapidly renewable resource and is 100% biodegradable/compostable. Contributes points toward LEED v4, CDPH v1.2, VOC free, no chemical irritants, no formaldehyde, and is free of other harmful substances. Compliant with Living Building Challenge criteria & DECLARE Red List Free.
<b>Variation</b>	PET felt panels are created through a manufacturing process known as 'felting'. This process results in a heathered appearance. Multiple color tones may appear in the same panel. Slight color variations should be expected.	Due to its 100% natural origin, the raw fibers of wool felt contain inclusions and color variations throughout the material. Color matching is not guaranteed between dye lots and inconsistencies may be more prominent in volumes that exceed the normal commercial standard.

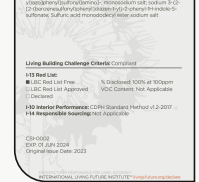
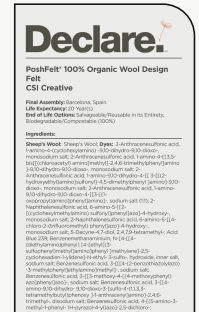
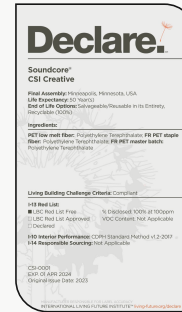

\*Approximate. NRC rating may vary due to product dimensions and spacing.

## Dimensions

### Standard Unit Dimensions

Typical ranges for height and width.

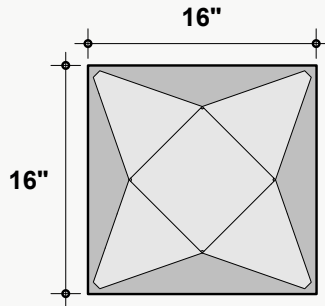

### Standard Unit Thicknesses

Thickness is independent of material layer selection.



### Custom Opportunity

Product dimensions can be manipulated in order to fit your design aesthetic and site conditions.

## Product Details

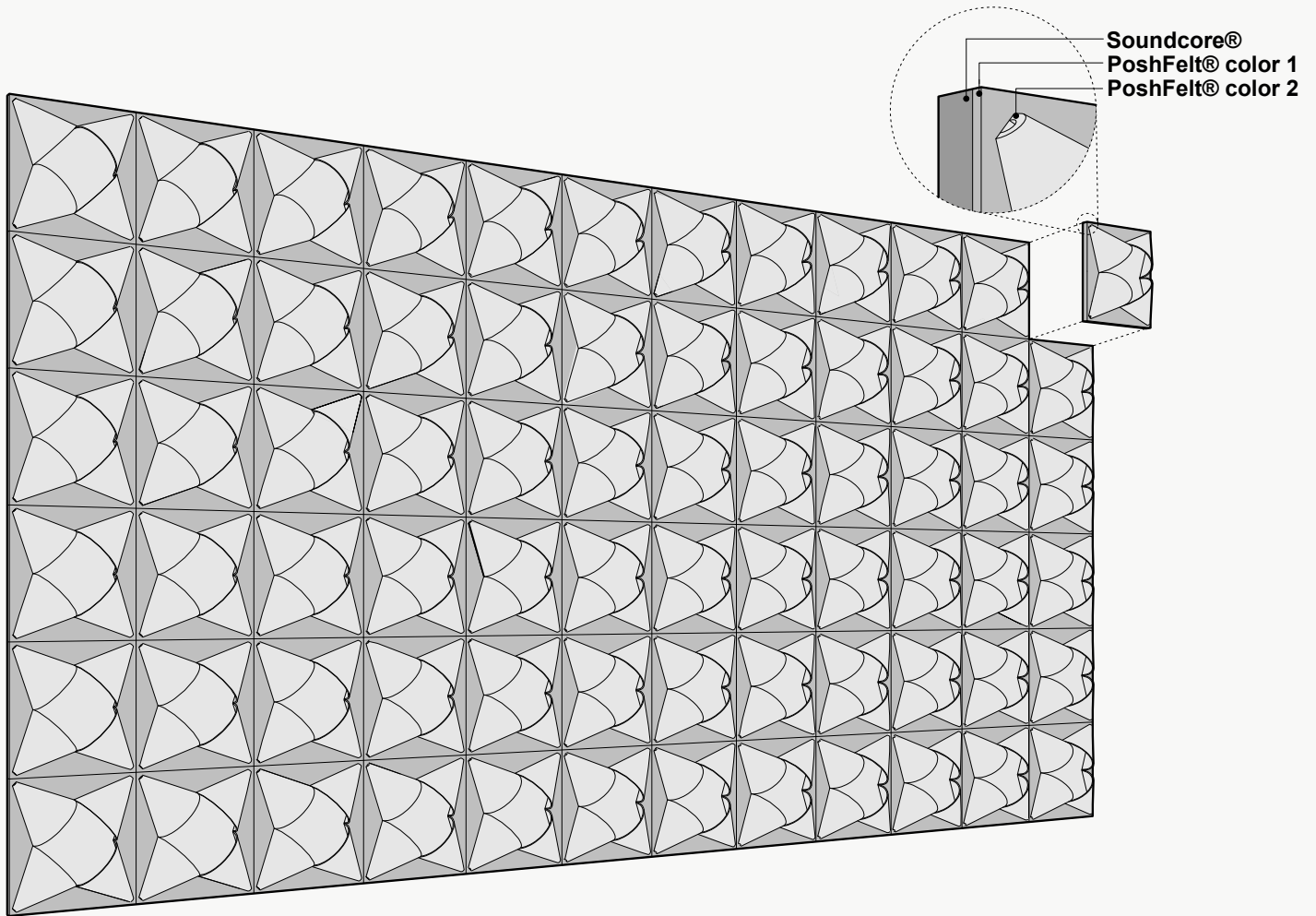

## Installation Options\*

All products and installation methods can be **customized** to meet the unique requirements of your space.

### Adhesive Direct Advantages

Attachment solution using an adhesive to apply directly to an existing surface or substrate.

- + Fastest installation time
- + No gap between target surface and product
- + Lowest profile installation option
- + Easiest to install
- + Most versatile installation option

Available methods: Construction Adhesive, Peel & Stick, Custom

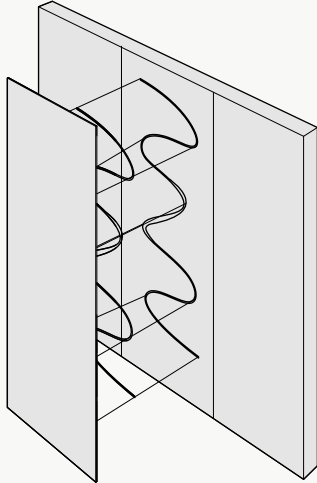

### Mechanical Direct Advantages

Attachment solution using physical hardware to attach to an existing surface or substrate.

- + No clamping or dry time necessary
- + Easy to remove and does not damage the substrate when removed
- + Most appropriate installation solution for heavier products
- + Provides an opportunity for an air gap, which can increase the acoustic value of a product

Available methods: Z-Clips, Panel Clips, Standoffs, Screw & Washer, Magnet, Custom

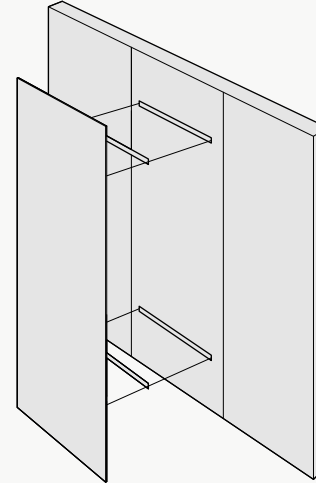

\*Not all listed attachment methods may be applicable to this product.

## Material Layers

### Soundcore®

Our recycled PET felt creates an acoustic barrier, defending against wandering white noise and irritating echoes.

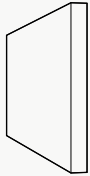

Single Layer  
½" Thickness

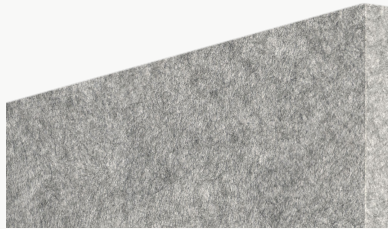

### PoshFelt® Exposed Edge

100% organic, natural wool design felt brings out the best experience in your space with color, comfort, and simple sustainability. Exposed edge products leave the Soundcore® layer uncovered, allowing for unique color combinations.

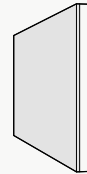

Multi-Layer  
Adds ⅛"-¼" to Material Thickness



### Soundcore® Wood Textures



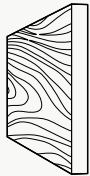

Soundcore® wood textures provide the natural aesthetic of wood while maintaining all the acoustic benefits of PET felt. Custom texture opportunities are also available upon request.



Single Layer  
½" Thickness

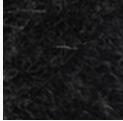
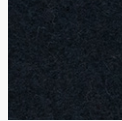
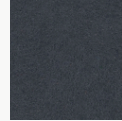

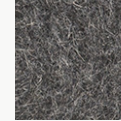
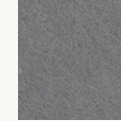
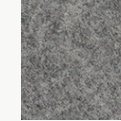
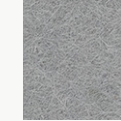
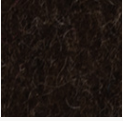
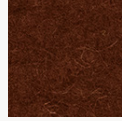
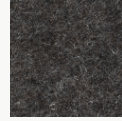
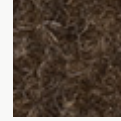
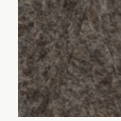
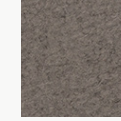
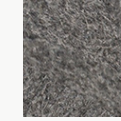
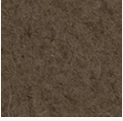
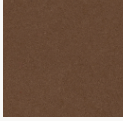
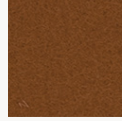
PoshFelt® | 3mm Thickness

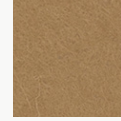
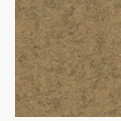
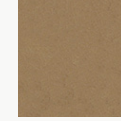
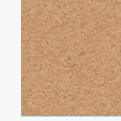
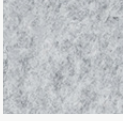
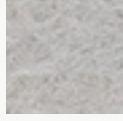
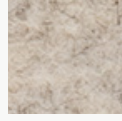
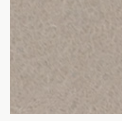
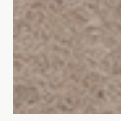
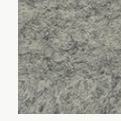
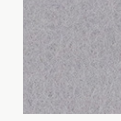
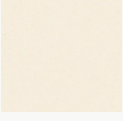
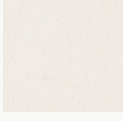
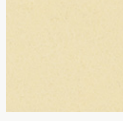
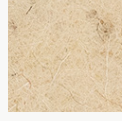
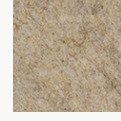
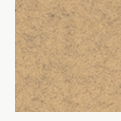
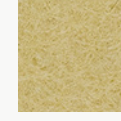
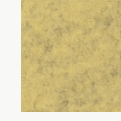
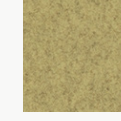
									
<b>PSH005</b> Black Beauty	<b>PSH161</b> Black Swan	<b>PSH266</b> Koala	<b>PSH627</b> Blackberry	<b>PSH265</b> Slag	<b>PSH513</b> Gravel	<b>PSH001</b> Gray Matter	<b>PSH004</b> Porpoise	<b>PSH176</b> Warmstone	<b>PSH512</b> Ash Plume
									
<b>PSH545</b> Henna	<b>PSH249</b> French Press	<b>PSH146</b> Auburn	<b>PSH521</b> Cocoa	<b>PSH179</b> Arctic Seal	<b>PSH180</b> Iron Ore	<b>PSH505</b> Garrigue	<b>PSH003</b> Otter	<b>PSH520</b> Silt	<b>PSH002</b> Heather
									
<b>PSH504</b> Earth	<b>PSH255</b> Tropical Walnut	<b>PSH269</b> Canyon	<b>PSH253</b> Toffee	<b>PSH602</b> Cafe	<b>PSH281</b> Great Plains	<b>PSH503</b> Savanna	<b>PSH509</b> Cairo	<b>PSH621</b> Pan	<b>PSH291</b> Gobi
									
<b>PSH299</b> Mountain Breeze	<b>PSH300</b> Crevasse	<b>PSH625</b> Silver Chain	<b>PSH515</b> Blizzard	<b>PSH127</b> Mocha	<b>PSH635</b> Eggshell	<b>PSH178</b> Fawn	<b>PSH175</b> Dovetail	<b>PSH624</b> Dapple Gray	<b>PSH609</b> Cityscape
									
<b>PSH118</b> Ivory Lace	<b>PSH174</b> Cotton	<b>PSH293</b> Pound Cake	<b>PSH519*</b> Cupcake	<b>PSH630</b> Sand Dune	<b>PSH006</b> Shiitake	<b>PSH301</b> Tumbleweed	<b>PSH637</b> Chiffon	<b>PSH304</b> Sugar Cookie	<b>PSH541</b> Banana Bread

\*6-roll MOQ

PoshFelt® | 3mm Thickness



PSH215  
Raincoat



PSH622  
Corn



PSH295  
Sunrise Peach



PSH507  
Hive



PSH015  
Honey



PSH305  
Dandelion

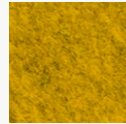

PSH216  
Lion's Den



PSH634  
Amber



PSH261  
Pale Ale



PSH638  
Sunflower



PSH610  
Coral



PSH632  
Peach



PSH218  
Citrus



PSH532  
Harvest



PSH014  
Knockout Orange

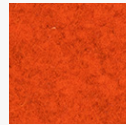

PSH307  
Orange Nectar



PSH633  
Clementine



PSH245  
Fire Agate



PSH525  
Olympus



PSH640  
Rusted

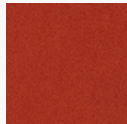

PSH139  
Cayenne



PSH535  
Guppy

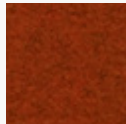

PSH528  
Ferrous



PSH296  
Paprika



PSH530  
Hot Iron

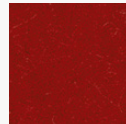

PSH537  
Cardinal

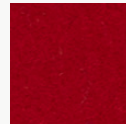

PSH008  
Bonfire



PSH308  
Scarlet

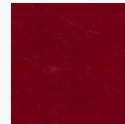

PSH009  
Poinsettia

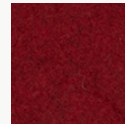

PSH527  
Red Velvet



PSH137  
Passion Flower

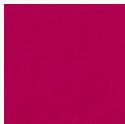

PSH273  
Ultraviolet

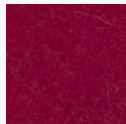

PSH649  
Pomegranate

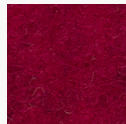

PSH617  
Evening Gown

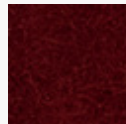

PSH540  
Devil's Food

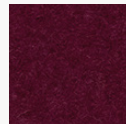

PSH644  
Maroon

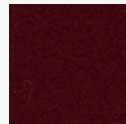

PSH210  
Sangria

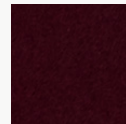

PSH211  
Cherry Chutney

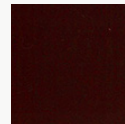

PSH212  
Vino

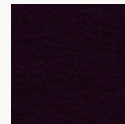

PSH514  
Red Wine



PSH272  
Hotwire



PSH302  
Heather Pink



PSH202  
Crush

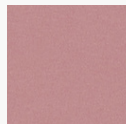

PSH647  
Eden Rose

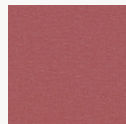

PSH643  
Rhododendron

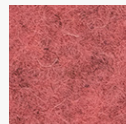

PSH560  
Schiava

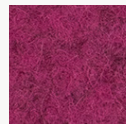

PSH559  
Monroe

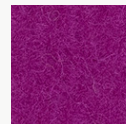

PSH544  
Dragonfruit



PSH309  
Allium

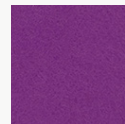

PSH205  
Mulberry



PoshFelt® | 3mm Thickness

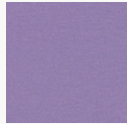

PSH612  
Lilac



PSH646  
Lupine



PSH274  
Amethyst



PSH523  
Violet Sky



PSH546  
Tyrian Plum



PSH142  
Plum Purple



PSH286  
Viper

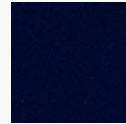

PSH241  
Tranquilo

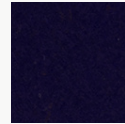

PSH550  
Mariana

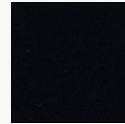

PSH277  
Shade

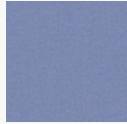

PSH615  
Imagine

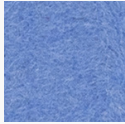

PSH510  
Ozone



PSH237  
Hotspring



PSH508  
Oahu

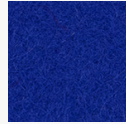

PSH548  
Ultramarine

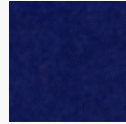

PSH160  
Admiral Blue



PSH239  
Speckled Navy



PSH561  
Neptune



PSH645  
Space



PSH614  
Blueberry



PSH502  
Pacific



PSH238  
Cobalt



PSH152  
Blue Nile

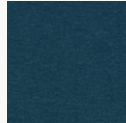

PSH616  
Fountain

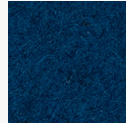

PSH516  
Actun



PSH511  
Lagoon

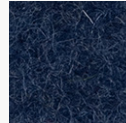

PSH636  
Navy Blue

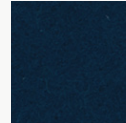

PSH260  
Twilight

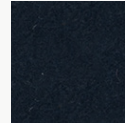

PSH310  
Deep Royal



PSH278  
Squid Ink



PSH606  
Midday



PSH306  
Swell

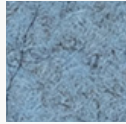

PSH608  
Diamond Dust

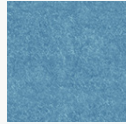

PSH605  
Meander



PSH628  
Cozumel



PSH016  
Freshwater



PSH650  
Waterfall



PSH149  
Jamaica Bay

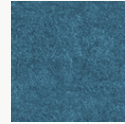

PSH604  
Atlantic

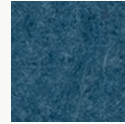

PSH648  
Aegean

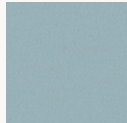

PSH639  
Glacier

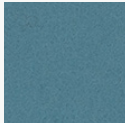

PSH287  
Sea Breeze

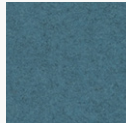

PSH631  
Adriatic

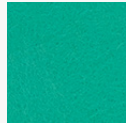

PSH232  
Seaglass



PSH629  
Robin's Egg



PSH517  
Sky Stone

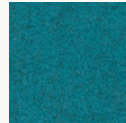

PSH552  
Cancun

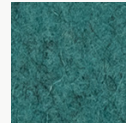

PSH642  
Blue Spruce

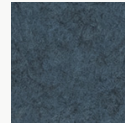

PSH623  
Steel Gray

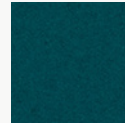

PSH564  
Jazz

PoshFelt® | 3mm Thickness



**PSH618**  
Iguana



**PSH641**  
Basil

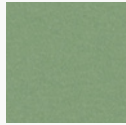

**PSH619**  
Springtime

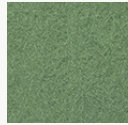

**PSH213**  
Meadow

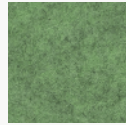

**PSH303**  
Feather Moss

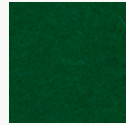

**PSH226**  
Grove



**PSH298**  
Peacock



**PSH234**  
Ocean Trench



**PSH311**  
Emerald



**PSH626**  
Evergreen



**PSH225**  
Everglade



**PSH164**  
Fresh Lime



**PSH554**  
Cyber Green



**PSH555**  
Hemlocks

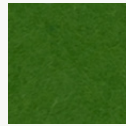

**PSH012**  
Shamrock

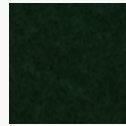

**PSH228**  
Forest Haze

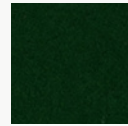

**PSH227**  
Succulent

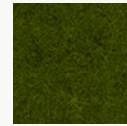

**PSH563**  
Rosemary

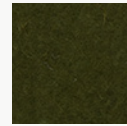

**PSH501**  
Mire



**PSH506**  
Bracken

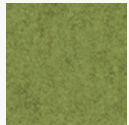

**PSH562**  
Aurora

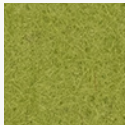

**PSH556**  
Avocado

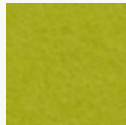

**PSH013**  
Parakeet

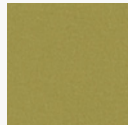

**PSH611**  
Haybale

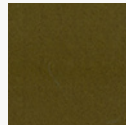

**PSH312**  
Safari

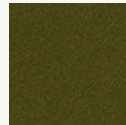

**PSH230**  
Camouflage

Soundcore® | 1/2" Thickness



SND019  
Linen

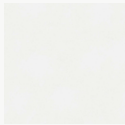

SND037  
Paper



SND134  
Oat



SND135  
Vanilla Bean



SND105  
Sand Dollar



SND109  
Macadamia



SND111  
Lanai



SND130  
Buckskin

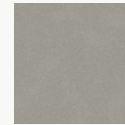

SND131  
Abalone

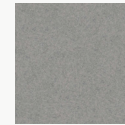

SND125  
Chinchilla



SND118  
Anchor



SND126  
Wolfhound



SND110  
Starry Night



SND102  
Morning Fog

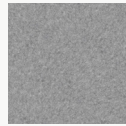

SND114  
Lunar Dust



SND034  
Granite Peak

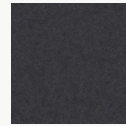

SND132  
Cast Iron



SND103  
Storm Cloud



SND038  
Inkwell



SND122  
Briquette



SND127  
Burnt Toast



SND108  
Ablaze



SND104  
Pumpkin



SND106  
Goldfinch

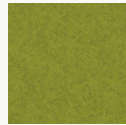

SND113  
Gruner

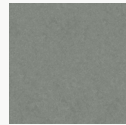

SND129  
Dried Thyme



SND107  
Grasshopper

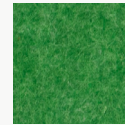

SND136  
Clover



SND138  
Fern

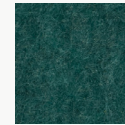

SND137  
Cove



SND112  
Tulum



SND139  
Tidal



SND121  
Apatite

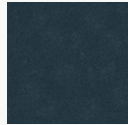

SND123  
Chrysocolla



SND117  
Serene



SND124  
Ice Floe



SND115  
Mako

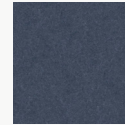

SND128  
Arctic Ocean

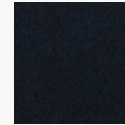

SND133  
Galactic



SND116  
Blue Marlin

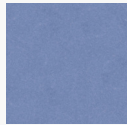

SND042  
Denim



SND140  
Marine

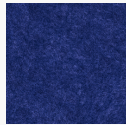

SND101  
Commodore

Soundcore® Wood Textures | 1/2" Thickness



**SND716**  
Dark Teak



**SND792**  
Dark Oak



**SND715**  
Dark Cherry



**SND793**  
Vintage Maple



**SND794**  
Warm Teak



**SND714**  
English Walnut



**SND713**  
Honey Walnut



**SND717**  
Warm Oak

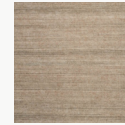

**SND790**  
Natural Teak

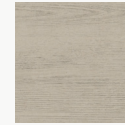

**SND712**  
Natural Spruce



**SND711**  
Bleached Cherry



**SND795**  
Light Teak



**SND709**  
White Maple



**SND791**  
Gray Oak

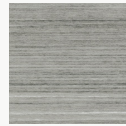

**SND710**  
Gray Teak