

Product Specifications

Product Name	Connect Clouds 010
Product ID	CLD-CON-010
Acoustics	0.60 - 0.70 NRC*
Lead Time	Lead time is dependent on project size. Contact us for more information.
Durability	Contract

Warranty	Comes with industry-leading standard warranty.
Flammability	ASTM E84: Class A
Custom	Custom colors and manufacturing services available. Additional charges and lead times may apply.
Maintenance	Vacuum occasionally to remove airborne dust or debris. Mild detergents or soaps may be used to remove stains. For detailed care instructions, refer to the CSI Creative Maintenance Information document.

Material Specifications

Soundcore®	
Content	Recycled PET acoustic felt
Weathering	Colorfast, non-deteriorating, non-hygroscopic
Environmental	Recycled PET acoustic felt is 60% post-consumer recycled content and is 100% recyclable. Contributes points toward LEED v4. CDPH v1.2. VOC free, non-toxic, non-allergenic, anti-microbial - does not attract mold and mildew. Compliant with Living Building Challenge criteria & DECLARE Red List Free.
Variation	PET felt panels are created through a manufacturing process known as 'felting'. This process results in a heathered appearance. Multiple color tones may appear in the same panel. Slight color variations should be expected.



*Approximate. NRC rating may vary due to product dimensions and spacing.

Dimensions

Standard Unit Dimensions

Typical ranges for length and width.

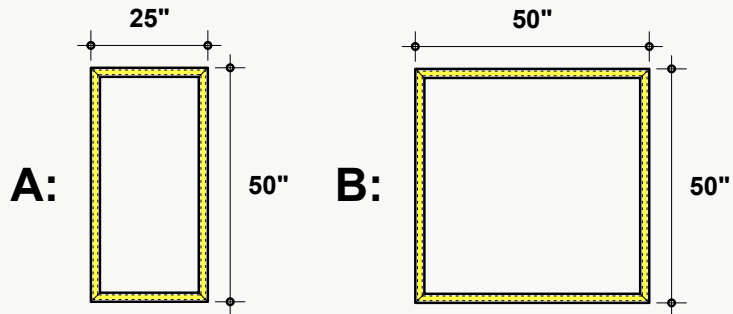

***Optional LED Light Available**

Standard Unit Thicknesses

Thickness is independent of material layer selection.

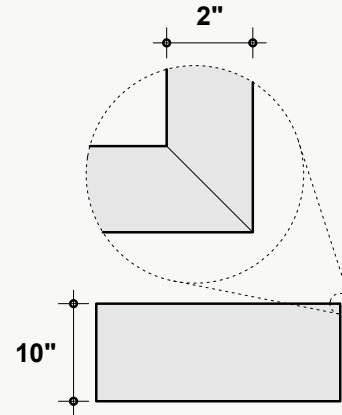

Custom Opportunity

Product dimensions can be manipulated in order to fit your design aesthetic and site conditions.

Product Details

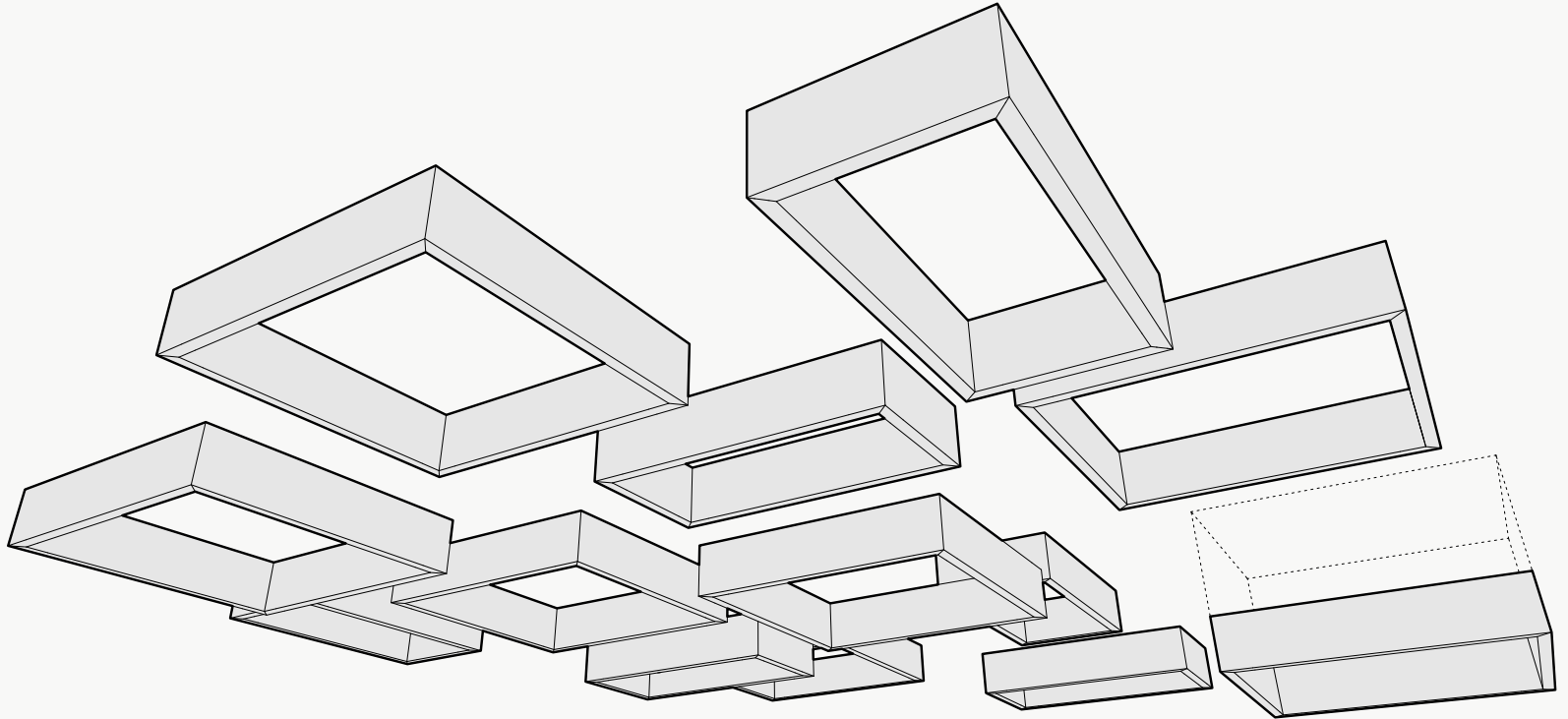

Lighting Integration

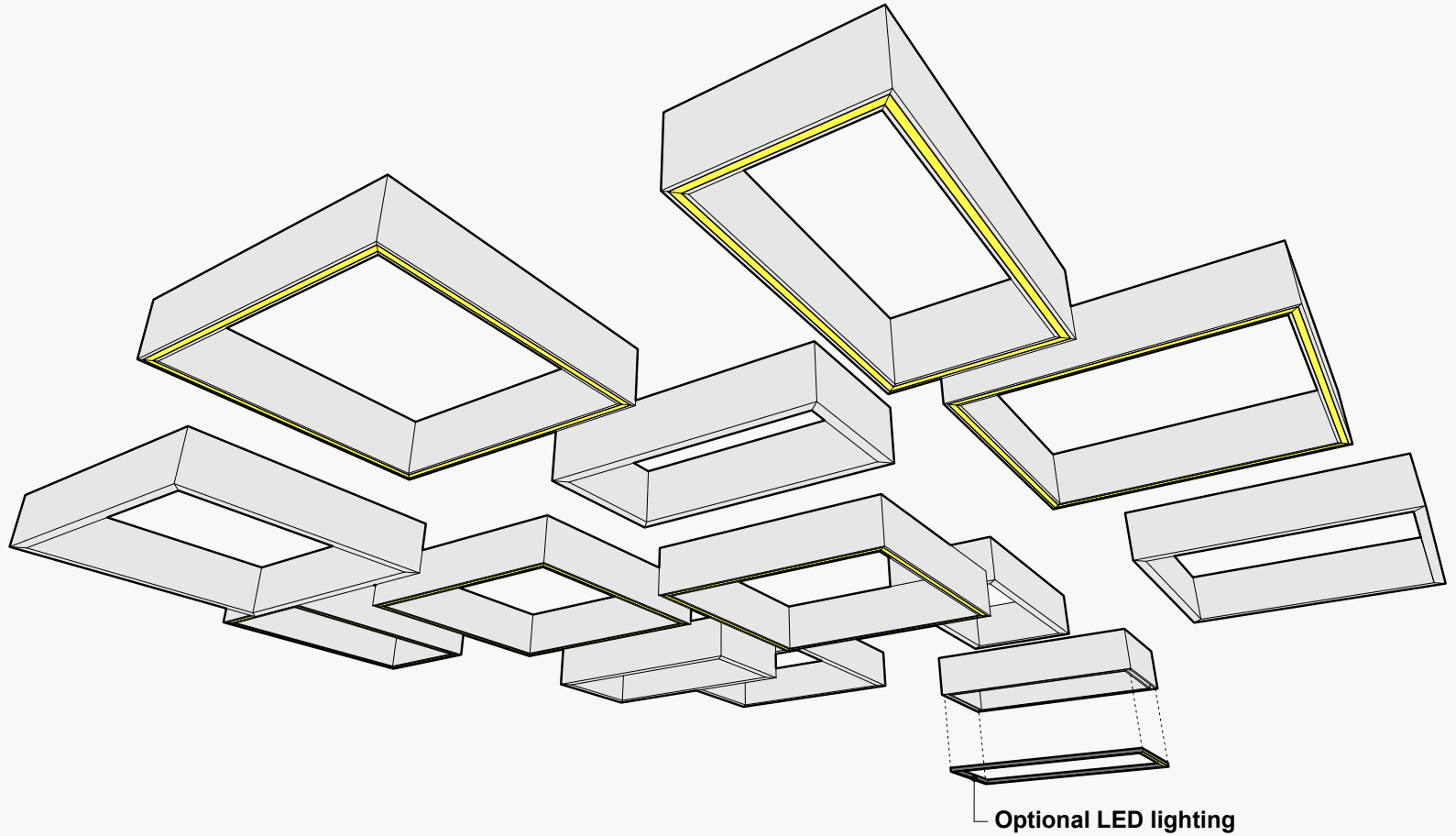

Configuration Options

The layouts shown are a summation of individual units. Individual units may be assembled in various arrangements to dictate the larger design. Configurations shown are suggested, but can be rearranged to achieve a custom layout.

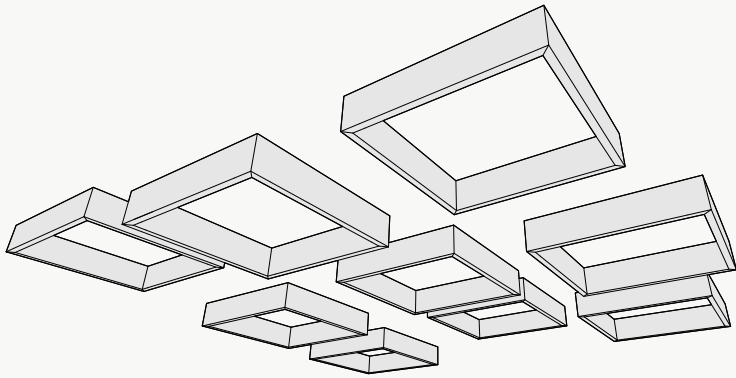

Uniform

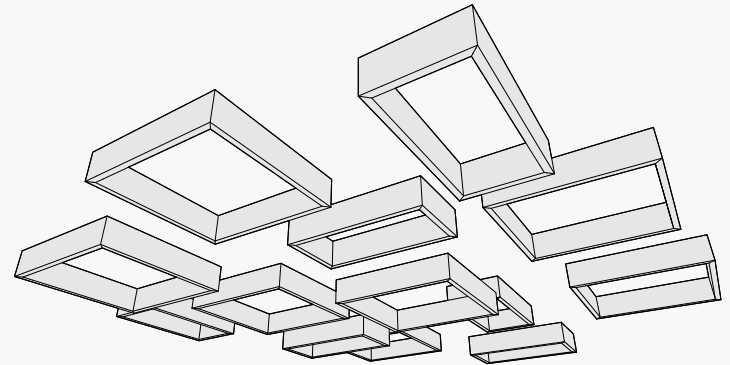

Combination

Lighting Specs

Lighting Fixture Features:

- + Square profile: 0.93" x 1.00"
- + UL Certified
- + ALCOA 6063 - T5 Aluminum Alloy

98° (average) - Performance Per 1" - Tested at 4200K, 90+ CRI

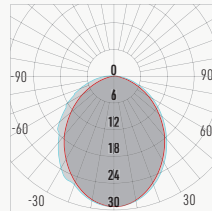

LP1			
CCT	3000K	3500K	4200K
Watts	1.5	1.5	1.5
Lumen	65	65	68
Lumen / W	41	41	43
Ratio	0.95	0.96	1.00

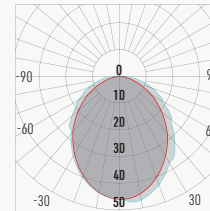

LP2			
CCT	3000K	3500K	4200K
Watts	2.9	2.9	2.9
Lumen	105	106	110
Lumen / W	40	40	42
Ratio	0.95	0.96	1.00

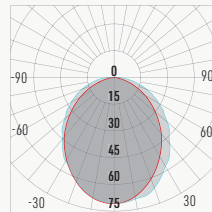

LP3			
CCT	3000K	3500K	4200K
Watts	4.4	4.4	4.4
Lumen	163	165	172
Lumen / W	41	41	43
Ratio	0.95	0.96	1.00

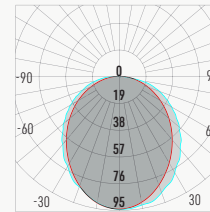

LP4			
CCT	3000K	3500K	4200K
Watts	5.4	5.4	5.4
Lumen	245	248	258
Lumen / W	45	46	48
Ratio	0.95	0.96	1.00

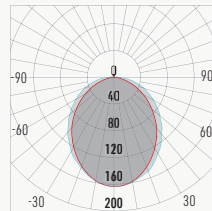

LHP			
CCT	3000K	3500K	4200K
Watts	7.0	7.0	7.0
Lumen	388	392	408
Lumen / W	51	52	54
Ratio	0.95	0.96	1.00

Attachment Methods*

Aircraft Cable

- + Fastest/easiest height adjustment
- + Largest height adjustment range
- + Height and angle versatility
- + Accommodates uneven ceiling surfaces and MEP

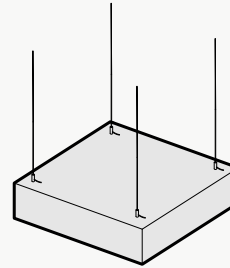

Threaded Rod

- + Reduced product sway
- + Height and angle versatility
- + Accommodates uneven ceiling surfaces and MEP

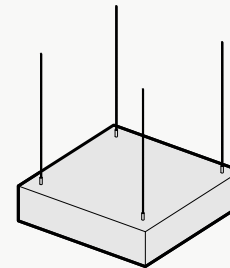

Mechanical Direct

- + Lowest profile installation method
- + Eliminates product sway
- + Connects to: Unistrut, ACT Grid, flat ceiling surfaces
- + Connections: Magnets, Grid Clips, Panel Clips, Metal Bracket, Custom

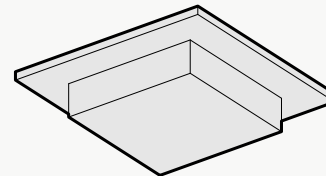

*Not all listed attachment methods may be applicable to this product.

Material Layers

Soundcore®

Our recycled PET felt creates an acoustic barrier, defending against wandering white noise and irritating echoes.

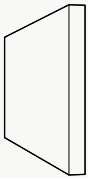

Single Layer
½" Thickness

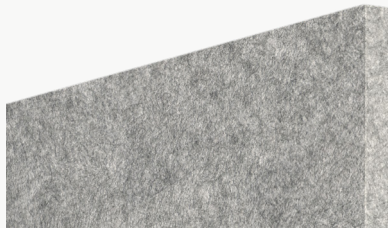

Soundcore® Wood Textures

Soundcore® wood textures provide the natural aesthetic of wood while maintaining all the acoustic benefits of PET felt. Custom texture opportunities are also available upon request.



Single Layer
½" Thickness



Soundcore® | 1/2" Thickness

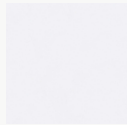

SND019
Linen

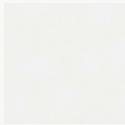

SND037
Paper



SND134
Oat

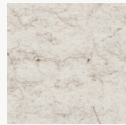

SND135
Vanilla Bean



SND105
Sand Dollar



SND109
Macadamia



SND111
Lanai



SND130
Buckskin



SND131
Abalone



SND125
Chinchilla



SND118
Anchor



SND126
Wolfhound



SND110
Starry Night



SND102
Morning Fog

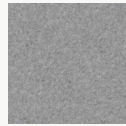

SND114
Lunar Dust

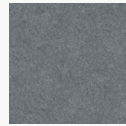

SND034
Granite Peak

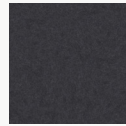

SND132
Cast Iron

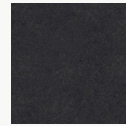

SND103
Storm Cloud



SND038
Inkwell



SND122
Briquette



SND127
Burnt Toast



SND108
Ablaze



SND104
Pumpkin



SND106
Goldfinch



SND113
Gruner

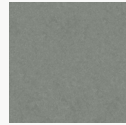

SND129
Dried Thyme



SND107
Grasshopper

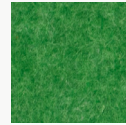

SND136
Clover

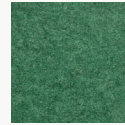

SND138
Fern

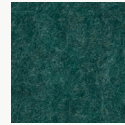

SND137
Cove



SND112
Tulum



SND139
Tidal



SND121
Apatite

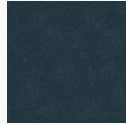

SND123
Chrysocolla



SND117
Serene

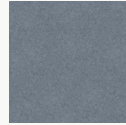

SND124
Ice Floe

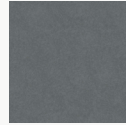

SND115
Mako

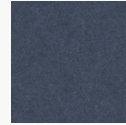

SND128
Arctic Ocean

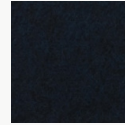

SND133
Galactic



SND116
Blue Marlin

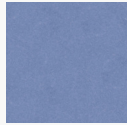

SND042
Denim



SND140
Marine

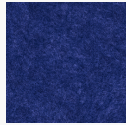

SND101
Commodore

Soundcore® Wood Textures | 1/2" Thickness



SND716
Dark Teak



SND792
Dark Oak



SND715
Dark Cherry



SND793
Vintage Maple

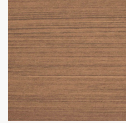

SND794
Warm Teak

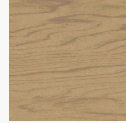

SND714
English Walnut

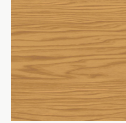

SND713
Honey Walnut

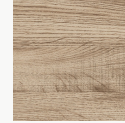

SND717
Warm Oak

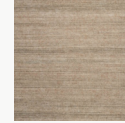

SND790
Natural Teak

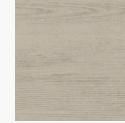

SND712
Natural Spruce



SND711
Bleached Cherry



SND795
Light Teak



SND709
White Maple



SND791
Gray Oak

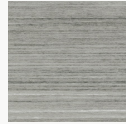

SND710
Gray Teak