

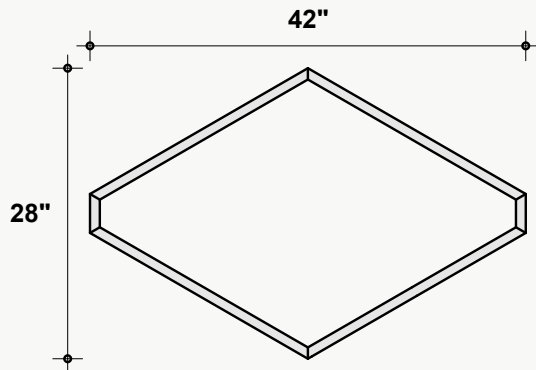

## Dimensions

### Standard Unit Dimensions

Typical ranges for length and width.



### Custom Opportunity

Product dimensions can be manipulated in order to fit your design aesthetic and site conditions.

### Standard Unit Thicknesses

Thickness is independent on material layer selection.

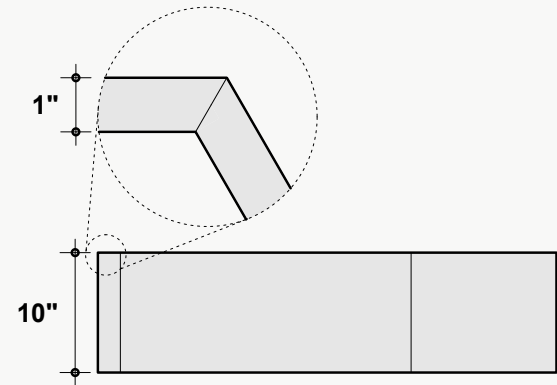

## Product Details

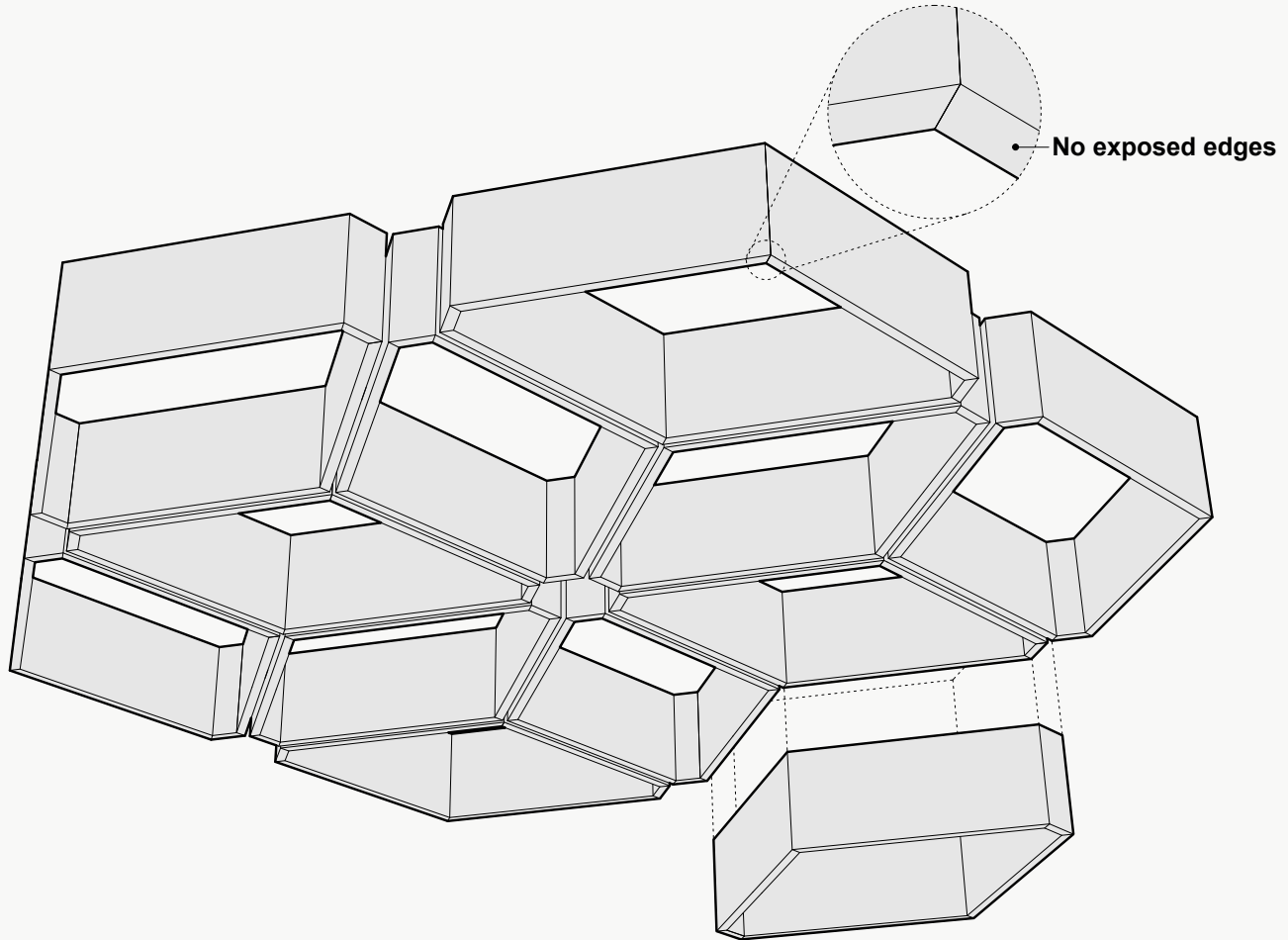

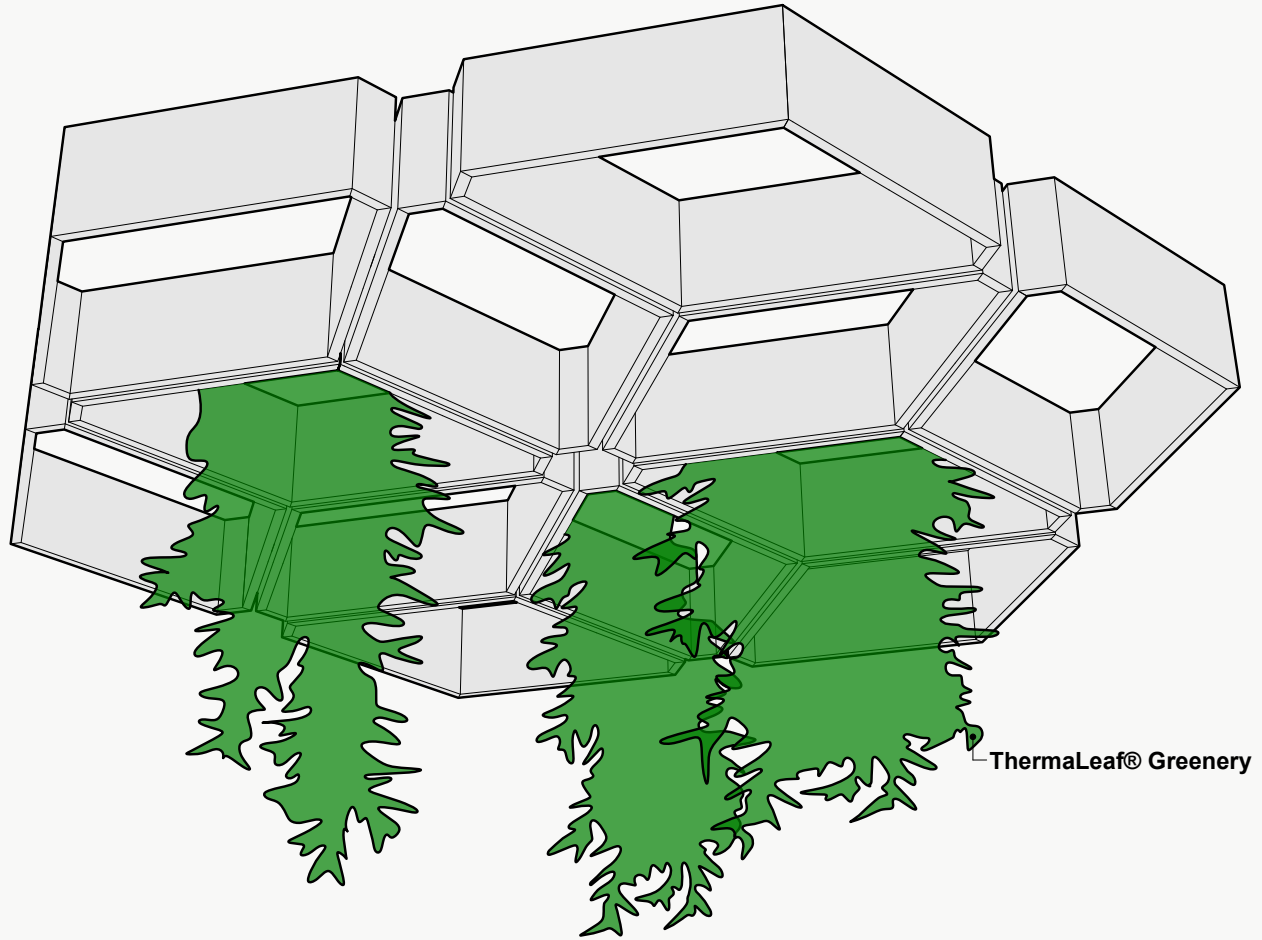

# ThermaLeaf® Greenery

Commercial Silk International's trademarked ThermaLeaf® artificial foliage is a proprietary formulation and manufacturing process whereby the fire retardants are impregnated directly into the raw materials of the foliage resulting in an inherently fire retardant "IFR" product.

- + ASTM E84-95 Class A Fired Rated
  - + Injected, non-topical treatment will not wash or wear off
  - + Long lasting, consistent fire protection
- 

## Available Greenery Configurations



Jasmine, White  
Jasmine, Salmon



Sweet Bay



Silver Inch Plant



Algerian Ivy



Algerian Ivy, Variegated



Grape Ivy



Lace Ivy



Lace Ivy, Variegated

# ThermaLeaf® Greenery

Commercial Silk International's trademarked ThermaLeaf® artificial foliage is a proprietary formulation and manufacturing process whereby the fire retardants are impregnated directly into the raw materials of the foliage resulting in an inherently fire retardant "IFR" product.

- + ASTM E84-95 Class A Fired Rated
  - + Injected, non-topical treatment will not wash or wear off
  - + Long lasting, consistent fire protection
- 

## Available Greenery Configurations



English Ivy



Golden Pothos



Heartleaf Philodendron



Heartleaf Philodendron,  
Limelight



Virginia Creeper

## Attachment Methods\*

### Aircraft Cable

- + Fastest/easiest height adjustment
- + Largest height adjustment range
- + Height and angle versatility
- + Accommodates uneven ceiling surfaces and MEP

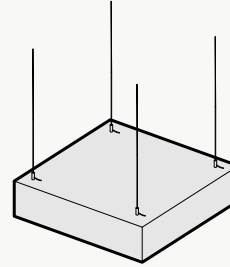

### Threaded Rod

- + Reduced product sway
- + Height and angle versatility
- + Accommodates uneven ceiling surfaces and MEP

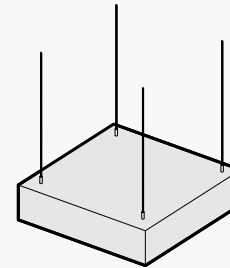

### Mechanical Direct

- + Lowest profile installation method
- + Eliminates product sway
- + Connects to: Unistrut, ACT Grid, flat ceiling surfaces
- + Connections: Magnets, Grid Clips, Panel Clips, Metal Bracket, Custom

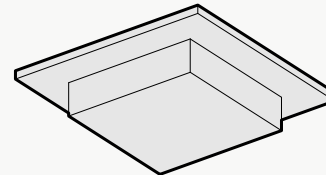

\*Not all listed attachment methods may be applicable to this product.



## Material Layers

### Soundcore®

Our recycled PET felt creates an acoustic barrier, defending against wandering white noise and irritating echoes.

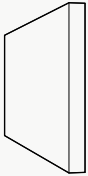

Single Layer  
½" Thickness

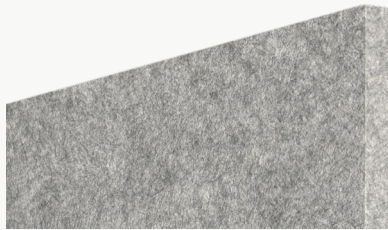

### Soundcore® Wood Textures

Soundcore® wood textures provide the natural aesthetic of wood while maintaining all the acoustic benefits of PET felt. Custom texture opportunities are also available upon request.



Single Layer  
½" Thickness



Soundcore® | 1/2" Thickness

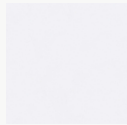

**SND019**  
Linen

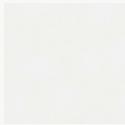

**SND037**  
Paper

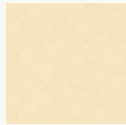

**SND134**  
Oat



**SND135**  
Vanilla Bean



**SND105**  
Sand Dollar



**SND109**  
Macadamia



**SND111**  
Lanai



**SND130**  
Buckskin



**SND131**  
Abalone

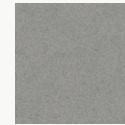

**SND125**  
Chinchilla



**SND118**  
Anchor



**SND126**  
Wolfhound



**SND110**  
Starry Night



**SND102**  
Morning Fog

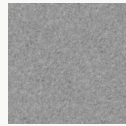

**SND114**  
Lunar Dust

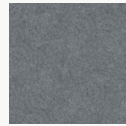

**SND034**  
Granite Peak

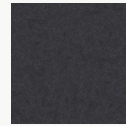

**SND132**  
Cast Iron



**SND103**  
Storm Cloud



**SND038**  
Inkwell



**SND122**  
Briquette



**SND127**  
Burnt Toast



**SND108**  
Ablaze



**SND104**  
Pumpkin



**SND106**  
Goldfinch

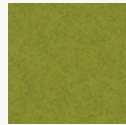

**SND113**  
Gruner

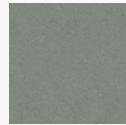

**SND129**  
Dried Thyme



**SND107**  
Grasshopper

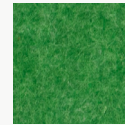

**SND136**  
Clover

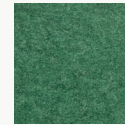

**SND138**  
Fern

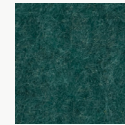

**SND137**  
Cove



**SND112**  
Tulum



**SND139**  
Tidal



**SND121**  
Apatite

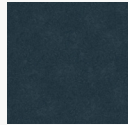

**SND123**  
Chrysocolla



**SND117**  
Serene



**SND124**  
Ice Floe

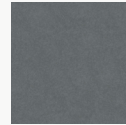

**SND115**  
Mako

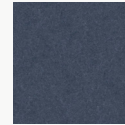

**SND128**  
Arctic Ocean

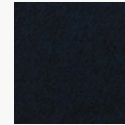

**SND133**  
Galactic



**SND116**  
Blue Marlin

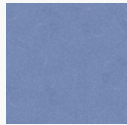

**SND042**  
Denim



**SND140**  
Marine

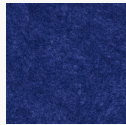

**SND101**  
Commodore

Soundcore® Wood Textures | 1/2" Thickness



**SND716**  
Dark Teak



**SND792**  
Dark Oak



**SND715**  
Dark Cherry



**SND793**  
Vintage Maple



**SND794**  
Warm Teak



**SND714**  
English Walnut



**SND713**  
Honey Walnut



**SND717**  
Warm Oak

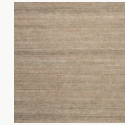

**SND790**  
Natural Teak

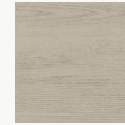

**SND712**  
Natural Spruce



**SND711**  
Bleached Cherry



**SND795**  
Light Teak



**SND709**  
White Maple

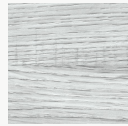

**SND791**  
Gray Oak

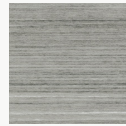

**SND710**  
Gray Teak