

Product Specifications

Product Name	Connect Clouds 006
Product ID	CLD-CON-006
Acoustics	0.60 - 0.70 NRC*
Lead Time	Lead time is dependent on project size. Contact us for more information.
Durability	Contract

Warranty	Comes with industry-leading standard warranty.
Flammability	ASTM E84: Class A
Custom	Custom colors and manufacturing services available. Additional charges and lead times may apply.
Maintenance	Vacuum occasionally to remove airborne dust or debris. Mild detergents or soaps may be used to remove stains. For detailed care instructions, refer to the CSI Creative Maintenance Information document.

Material Specifications

	Soundcore®	PoshFelt®
Content	Recycled PET acoustic felt	100% Merino or Karakul wool acoustic felt
Weathering	Colorfast, non-deteriorating, non-hygroscopic	Colorfast, non-deteriorating, non-woven, moisture resistant
Environmental	Recycled PET acoustic felt is 60% post-consumer recycled content and is 100% recyclable. Contributes points toward LEED v4, CDPH v1.2, VOC free, non-toxic, non-allergenic, anti-microbial - does not attract mold and mildew. Compliant with Living Building Challenge criteria & DECLARE Red List Free.	100% organic wool design felt is a rapidly renewable resource and is 100% biodegradable/compostable. Contributes points toward LEED v4, CDPH v1.2, VOC free, no chemical irritants, no formaldehyde, and is free of other harmful substances. Compliant with Living Building Challenge criteria & DECLARE Red List Free.
Variation	PET felt panels are created through a manufacturing process known as 'felting'. This process results in a heathered appearance. Multiple color tones may appear in the same panel. Slight color variations should be expected.	Due to its 100% natural origin, the raw fibers of wool felt contain inclusions and color variations throughout the material. Color matching is not guaranteed between dye lots and inconsistencies may be more prominent in volumes that exceed the normal commercial standard.

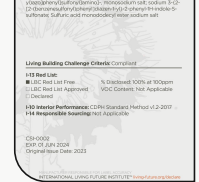
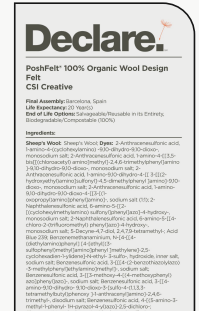
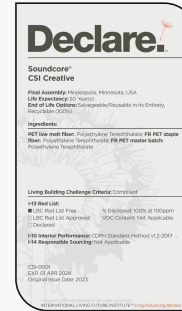

*Approximate. NRC rating may vary due to product dimensions and spacing.

Dimensions

Standard Unit Dimensions

Typical ranges for length and width.

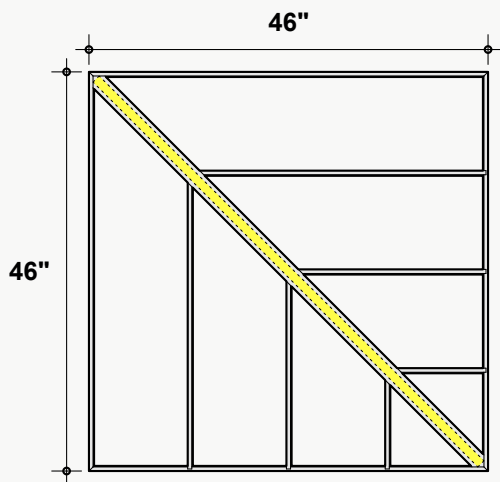

***Optional LED light available**

Standard Unit Thicknesses

Thickness is independent of material layer selection.

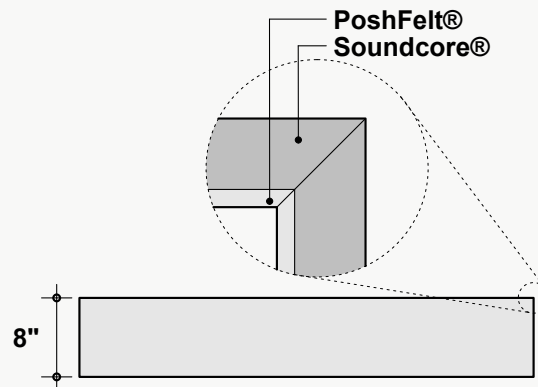

Custom Opportunity

Product dimensions can be manipulated in order to fit your design aesthetic and site conditions.

Product Details

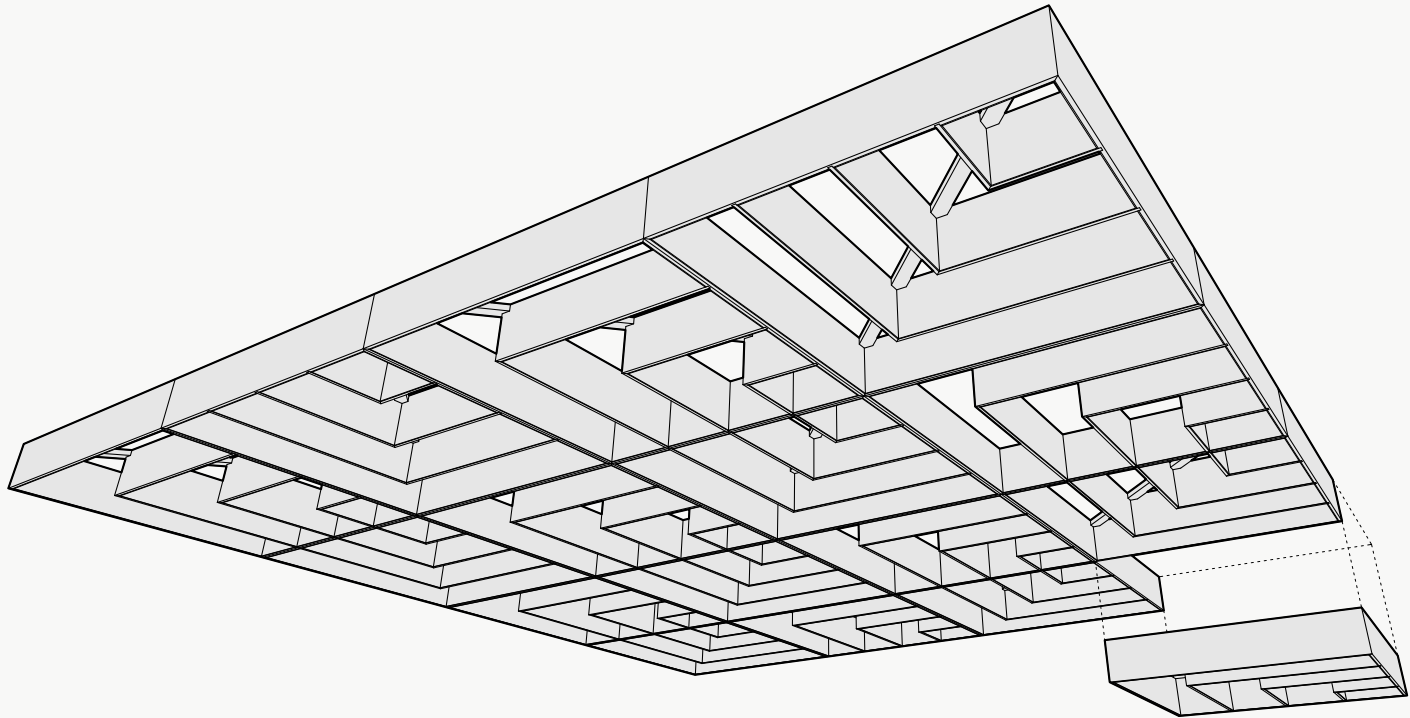

Configuration Options

The layouts shown are a summation of individual units. Individual units may be assembled in various arrangements to dictate the larger design. Configurations shown are suggested, but can be rearranged to achieve a custom layout.

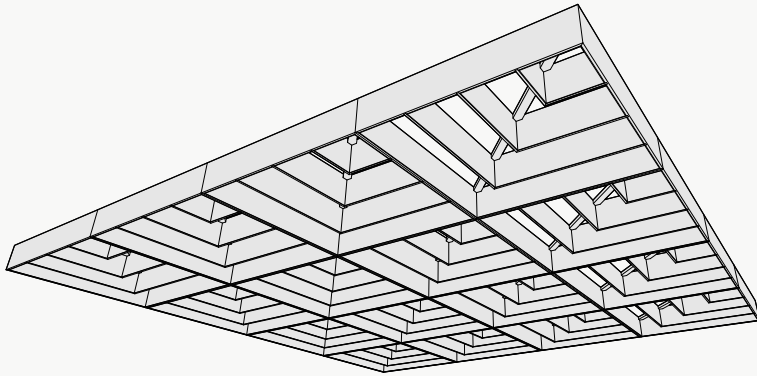

Uniform

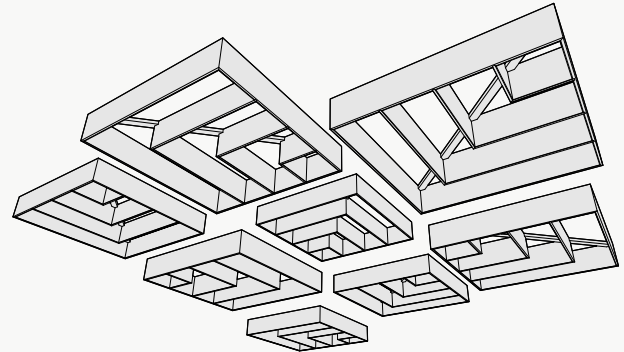

Independent

Lighting Specs

Lighting Fixture Features:

- + Square profile: 0.93" x 1.00"
- + UL Certified
- + ALCOA 6063 - T5 Aluminum Alloy

98° (average) - Performance Per 1" - Tested at 4200K, 90+ CRI

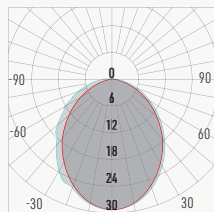

LP1			
CCT	3000K	3500K	4200K
Watts	1.5	1.5	1.5
Lumen	65	65	68
Lumen / W	41	41	43
Ratio	0.95	0.96	1.00

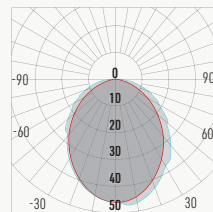

LP2			
CCT	3000K	3500K	4200K
Watts	2.9	2.9	2.9
Lumen	105	106	110
Lumen / W	40	40	42
Ratio	0.95	0.96	1.00

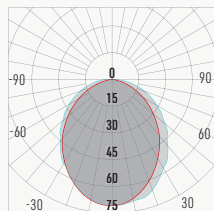

LP3			
CCT	3000K	3500K	4200K
Watts	4.4	4.4	4.4
Lumen	163	165	172
Lumen / W	41	41	43
Ratio	0.95	0.96	1.00

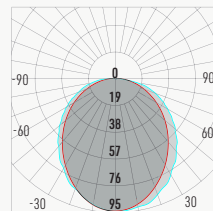

LP4			
CCT	3000K	3500K	4200K
Watts	5.4	5.4	5.4
Lumen	245	248	258
Lumen / W	45	46	48
Ratio	0.95	0.96	1.00

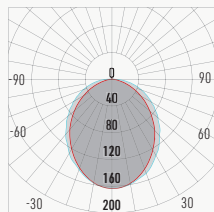

LHP			
CCT	3000K	3500K	4200K
Watts	7.0	7.0	7.0
Lumen	388	392	408
Lumen / W	51	52	54
Ratio	0.95	0.96	1.00

Attachment Methods*

Aircraft Cable

- + Fastest/easiest height adjustment
- + Largest height adjustment range
- + Height and angle versatility
- + Accommodates uneven ceiling surfaces and MEP

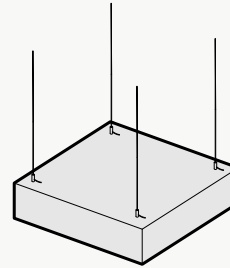

Threaded Rod

- + Reduced product sway
- + Height and angle versatility
- + Accommodates uneven ceiling surfaces and MEP

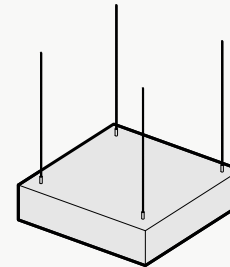

Mechanical Direct

- + Lowest profile installation method
- + Eliminates product sway
- + Connects to: Unistrut, ACT Grid, flat ceiling surfaces
- + Connections: Magnets, Grid Clips, Panel Clips, Metal Bracket, Custom

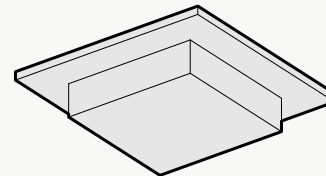

*Not all listed attachment methods may be applicable to this product.

Material Layers

Soundcore®

Our recycled PET felt creates an acoustic barrier, defending against wandering white noise and irritating echoes.

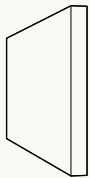

Single Layer
½" Thickness

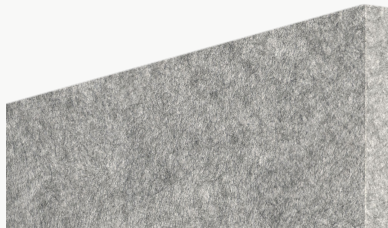

Soundcore® Wood Textures

Soundcore® wood textures provide the natural aesthetic of wood while maintaining all the acoustic benefits of PET felt. Custom texture opportunities are also available upon request.

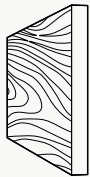

Single Layer
½" Thickness



PoshFelt® Exposed Edge



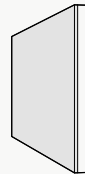







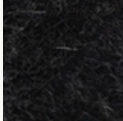
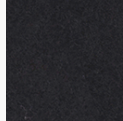
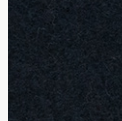
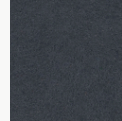
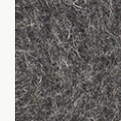
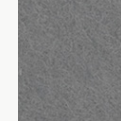
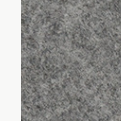
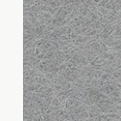

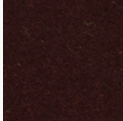
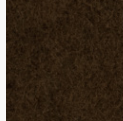
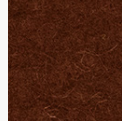
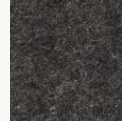
100% organic, natural wool design felt brings out the best experience in your space with color, comfort, and simple sustainability. Exposed edge products leave the Soundcore® layer uncovered, allowing for unique color combinations.

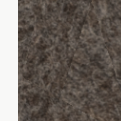
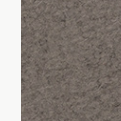
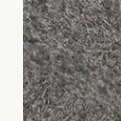

Multi-Layer
Adds ⅛"-¼" to Material Thickness

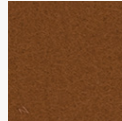
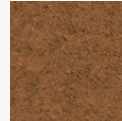
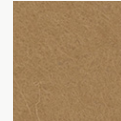
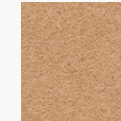
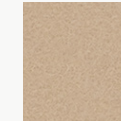

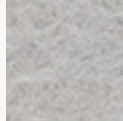
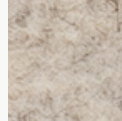
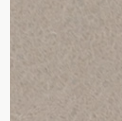
PoshFelt® | 3mm Thickness

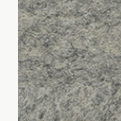
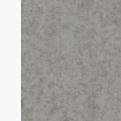
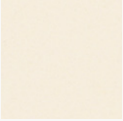
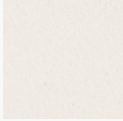
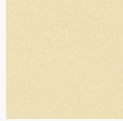
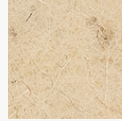
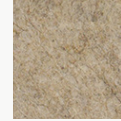
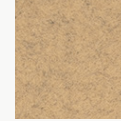
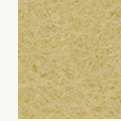
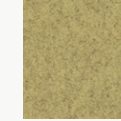











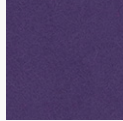



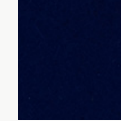
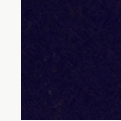
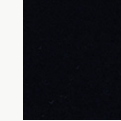

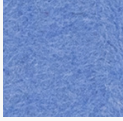

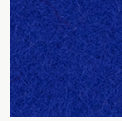
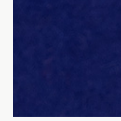

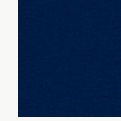

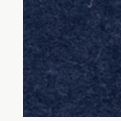

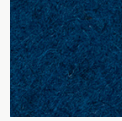

									
PSH005 Black Beauty	PSH161 Black Swan	PSH266 Koala	PSH627 Blackberry	PSH265 Slag	PSH513 Gravel	PSH001 Gray Matter	PSH004 Porpoise	PSH176 Warmstone	PSH512 Ash Plume
									
PSH545 Henna	PSH249 French Press	PSH146 Auburn	PSH521 Cocoa	PSH179 Arctic Seal	PSH180 Iron Ore	PSH505 Garrigue	PSH003 Otter	PSH520 Silt	PSH002 Heather
									
PSH504 Earth	PSH255 Tropical Walnut	PSH269 Canyon	PSH253 Toffee	PSH602 Cafe	PSH281 Great Plains	PSH503 Savanna	PSH509 Cairo	PSH621 Pan	PSH291 Gobi
									
PSH299 Mountain Breeze	PSH300 Crevasse	PSH625 Silver Chain	PSH515 Blizzard	PSH127 Mocha	PSH635 Eggshell	PSH178 Fawn	PSH175 Dovetail	PSH624 Dapple Gray	PSH609 Cityscape
									
PSH118 Ivory Lace	PSH174 Cotton	PSH293 Pound Cake	PSH519* Cupcake	PSH630 Sand Dune	PSH006 Shiitake	PSH301 Tumbleweed	PSH637 Chiffon	PSH304 Sugar Cookie	PSH541 Banana Bread

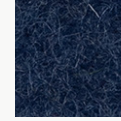
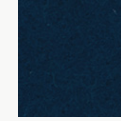
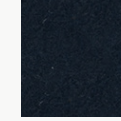
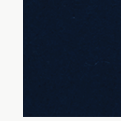
*6-roll MOQ

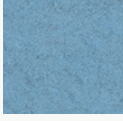
PoshFelt® | 3mm Thickness

									
PSH215 Raincoat	PSH622 Corn	PSH295 Sunrise Peach	PSH507 Hive	PSH015 Honey	PSH305 Dandelion	PSH216 Lion's Den	PSH634 Amber	PSH261 Pale Ale	PSH638 Sunflower
									
PSH610 Coral	PSH632 Peach	PSH218 Citrus	PSH532 Harvest	PSH014 Knockout Orange	PSH307 Orange Nectar	PSH633 Clementine	PSH245 Fire Agate	PSH525 Olympus	PSH640 Rusted
									
PSH139 Cayenne	PSH535 Guppy	PSH528 Ferrous	PSH296 Paprika	PSH530 Hot Iron	PSH537 Cardinal	PSH008 Bonfire	PSH308 Scarlet	PSH009 Poinsettia	PSH527 Red Velvet
									
PSH137 Passion Flower	PSH273 Ultraviolet	PSH649 Pomegranate	PSH617 Evening Gown	PSH540 Devil's Food	PSH644 Maroon	PSH210 Sangria	PSH211 Cherry Chutney	PSH212 Vino	PSH514 Red Wine
									
PSH272 Hotwire	PSH302 Heather Pink	PSH202 Crush	PSH647 Eden Rose	PSH643 Rhododendron	PSH560 Schiava	PSH559 Monroe	PSH544 Dragonfruit	PSH309 Allium	PSH205 Mulberry

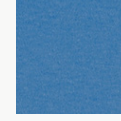
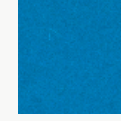
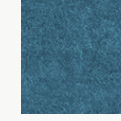
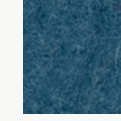
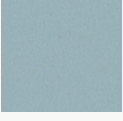
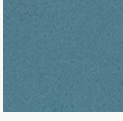
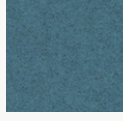
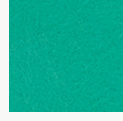
PoshFelt® | 3mm Thickness

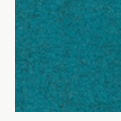
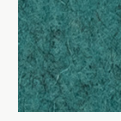
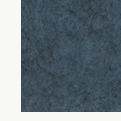
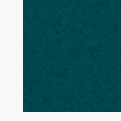
									
PSH612 Lilac	PSH646 Lupine	PSH274 Amethyst	PSH523 Violet Sky	PSH546 Tyrian Plum	PSH142 Plum Purple	PSH286 Viper	PSH241 Tranquilo	PSH550 Mariana	PSH277 Shade
									
PSH615 Imagine	PSH510 Ozone	PSH237 Hotspring	PSH508 Oahu	PSH548 Ultramarine	PSH160 Admiral Blue	PSH239 Speckled Navy	PSH561 Neptune	PSH645 Space	PSH614 Blueberry
									
PSH502 Pacific	PSH238 Cobalt	PSH152 Blue Nile	PSH616 Fountain	PSH516 Actun	PSH511 Lagoon	PSH636 Navy Blue	PSH260 Twilight	PSH310 Deep Royal	PSH278 Squid Ink
									
PSH606 Midday	PSH306 Swell	PSH608 Diamond Dust	PSH605 Meander	PSH628 Cozumel	PSH016 Freshwater	PSH650 Waterfall	PSH149 Jamaica Bay	PSH604 Atlantic	PSH648 Aegean
									
PSH639 Glacier	PSH287 Sea Breeze	PSH631 Adriatic	PSH232 Seaglass	PSH629 Robin's Egg	PSH517 Sky Stone	PSH552 Cancun	PSH642 Blue Spruce	PSH623 Steel Gray	PSH564 Jazz

PoshFelt® | 3mm Thickness



PSH618
Iguana



PSH641
Basil



PSH619
Springtime

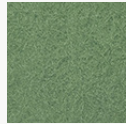

PSH213
Meadow

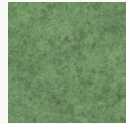

PSH303
Feather Moss



PSH226
Grove



PSH298
Peacock



PSH234
Ocean Trench



PSH311
Emerald



PSH626
Evergreen



PSH225
Everglade



PSH164
Fresh Lime



PSH554
Cyber Green



PSH555
Hemlocks



PSH012
Shamrock

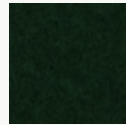

PSH228
Forest Haze

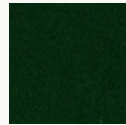

PSH227
Succulent



PSH563
Rosemary

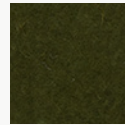

PSH501
Mire



PSH506
Bracken

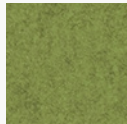

PSH562
Aurora

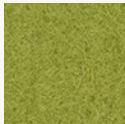

PSH556
Avocado

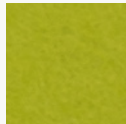

PSH013
Parakeet

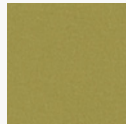

PSH611
Haybale

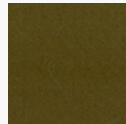

PSH312
Safari

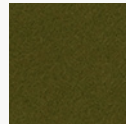

PSH230
Camouflage

Soundcore® | 1/2" Thickness

									
SND019 Linen	SND037 Paper	SND134 Oat	SND135 Vanilla Bean	SND105 Sand Dollar	SND109 Macadamia	SND111 Lanai	SND130 Buckskin	SND131 Abalone	SND125 Chinchilla
									
SND118 Anchor	SND126 Wolfhound	SND110 Starry Night	SND102 Morning Fog	SND114 Lunar Dust	SND034 Granite Peak	SND132 Cast Iron	SND103 Storm Cloud	SND038 Inkwell	SND122 Briquette
									
SND127 Burnt Toast	SND108 Ablaze	SND104 Pumpkin	SND106 Goldfinch	SND113 Gruner	SND129 Dried Thyme	SND107 Grasshopper	SND136 Clover	SND138 Fern	SND137 Cove
									
SND112 Tulum	SND139 Tidal	SND121 Apatite	SND123 Chrysocolla	SND117 Serene	SND124 Ice Floe	SND115 Mako	SND128 Arctic Ocean	SND133 Galactic	SND116 Blue Marlin
									
SND042 Denim	SND140 Marine	SND101 Commodore							

Soundcore® Wood Textures | 1/2" Thickness



SND716
Dark Teak



SND792
Dark Oak



SND715
Dark Cherry



SND793
Vintage Maple



SND794
Warm Teak

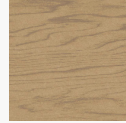

SND714
English Walnut

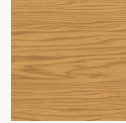

SND713
Honey Walnut

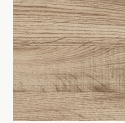

SND717
Warm Oak

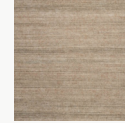

SND790
Natural Teak

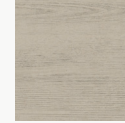

SND712
Natural Spruce



SND711
Bleached Cherry



SND795
Light Teak



SND709
White Maple



SND791
Gray Oak



SND710
Gray Teak