

# Product Specifications

<b>Product Name</b>	Carved Surfaces 029
<b>Product ID</b>	SUR-CRV-029
<b>Acoustics</b>	0.40 - 0.50 NRC*
<b>Lead Time</b>	Lead time is dependent on project size. Contact us for more information.
<b>Durability</b>	Contract

<b>Warranty</b>	Comes with industry-leading standard warranty.
<b>Flammability</b>	ASTM E84: Class A
<b>Custom</b>	Custom colors and manufacturing services available. Additional charges and lead times may apply.
<b>Maintenance</b>	Vacuum occasionally to remove airborne dust or debris. Mild detergents or soaps may be used to remove stains. For detailed care instructions, refer to the <b>CSI Creative Maintenance Information</b> document.

# Material Specifications

	<b>Soundcore®</b>	<b>PoshFelt®</b>
<b>Content</b>	Recycled PET acoustic felt	100% Merino or Karakul wool acoustic felt
<b>Weathering</b>	Colorfast, non-deteriorating, non-hygroscopic	Colorfast, non-deteriorating, non-woven, moisture resistant
<b>Environmental</b>	Recycled PET acoustic felt is 60% post-consumer recycled content and is 100% recyclable. Contributes points toward LEED v4, CDPH v1.2, VOC free, non-toxic, non-allergenic, anti-microbial - does not attract mold and mildew. Compliant with Living Building Challenge criteria & DECLARE Red List Free.	100% organic wool design felt is a rapidly renewable resource and is 100% biodegradable/compostable. Contributes points toward LEED v4, CDPH v1.2, VOC free, no chemical irritants, no formaldehyde, and is free of other harmful substances. Compliant with Living Building Challenge criteria & DECLARE Red List Free.
<b>Variation</b>	PET felt panels are created through a manufacturing process known as 'felting'. This process results in a heathered appearance. Multiple color tones may appear in the same panel. Slight color variations should be expected.	Due to its 100% natural origin, the raw fibers of wool felt contain inclusions and color variations throughout the material. Color matching is not guaranteed between dye lots and inconsistencies may be more prominent in volumes that exceed the normal commercial standard.

\*Approximate. NRC rating may vary due to product dimensions and spacing.

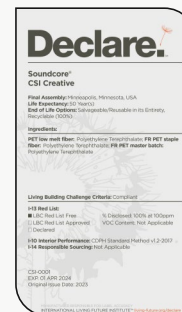

# Dimensions

## Standard Unit Dimensions

Typical ranges for height and width.

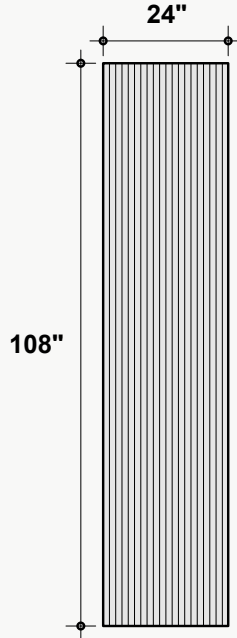

## Custom Opportunity

Product dimensions can be manipulated in order to fit your design aesthetic and site conditions.

## Standard Unit Thicknesses

Thickness is dependent on material layer selection.

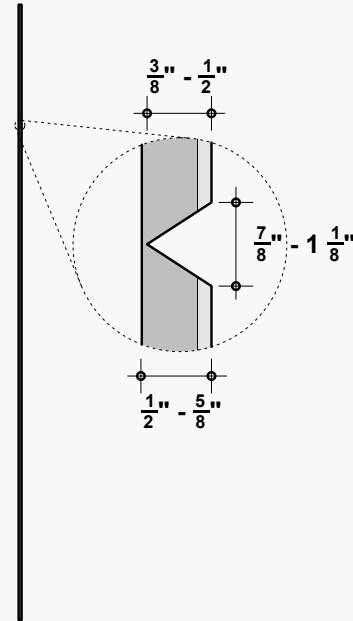

## Product Details

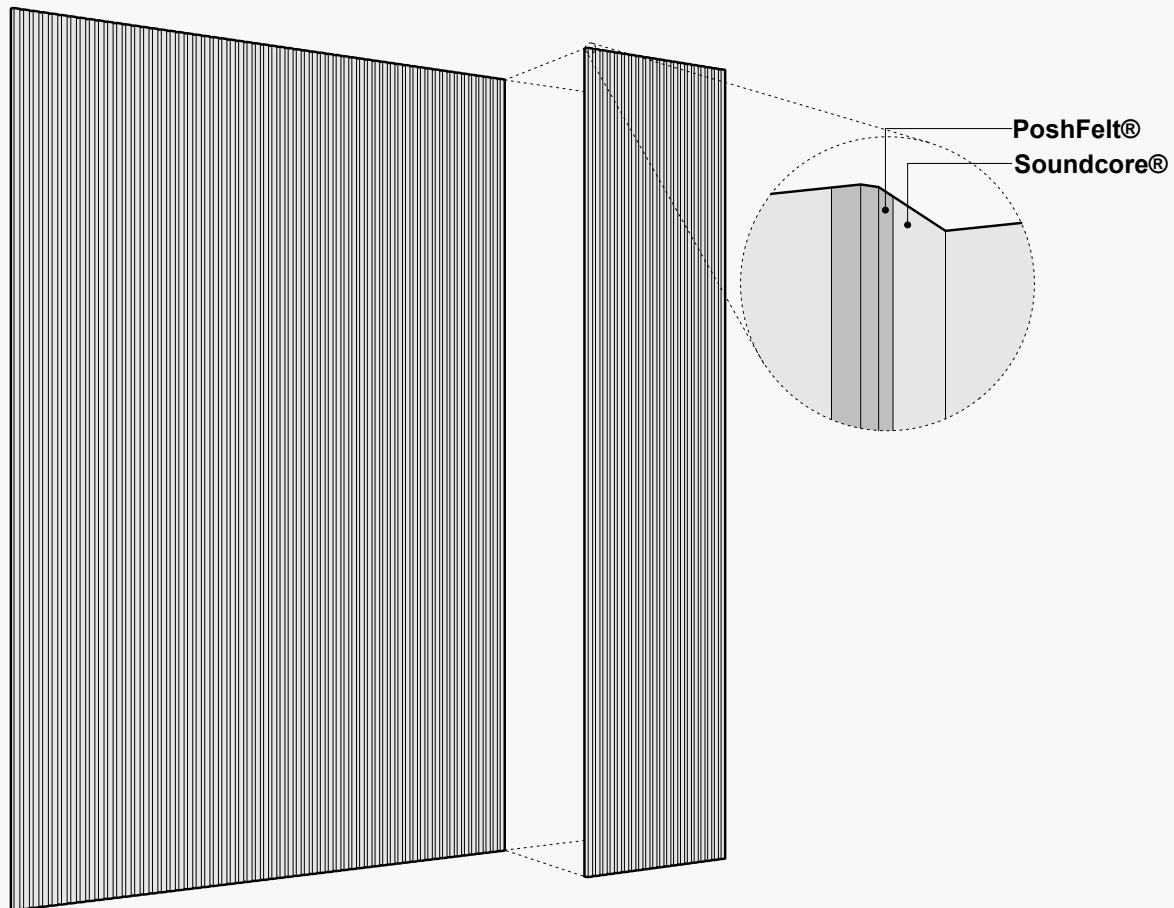

## Configuration Options

*The layouts shown are a summation of individual units. Individual units may be assembled in various arrangements to dictate the larger design. Configurations shown are suggested, but can be rearranged to achieve a custom layout.*

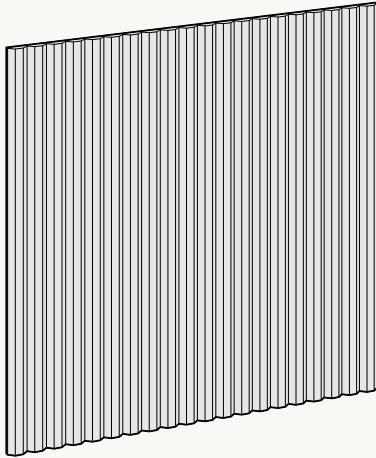

**Flat**

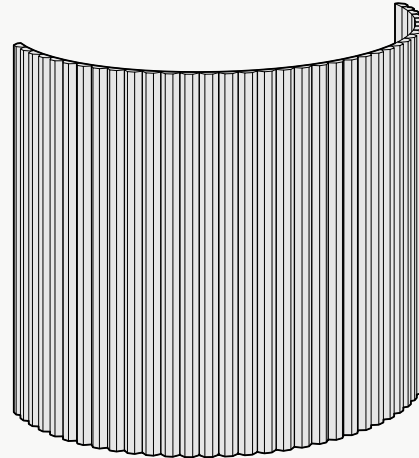

**Curved**

## Installation Options\*

All products and installation methods can be **customized** to meet the unique requirements of your space.

### Mechanical Direct Advantages

Attachment solution using physical hardware to attach to an existing surface or substrate.

- + No clamping or dry time necessary
- + Easy to remove and does not damage the substrate when removed
- + Most appropriate installation solution for heavier products
- + Provides an opportunity for an air gap, which can increase the acoustic value of a product

Available methods: Z-Clips, Panel Clips, Standoffs, Screw & Washer, Magnet, Custom

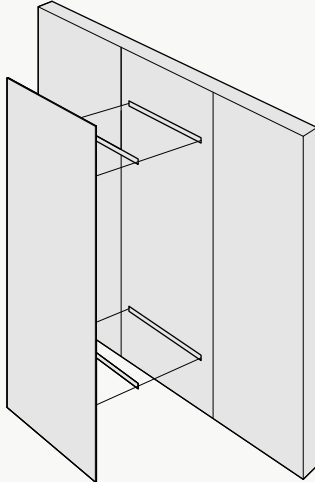

\*Not all listed attachment methods may be applicable to this product.

## Material Layers

### Soundcore®

Our recycled PET felt creates an acoustic barrier, defending against wandering white noise and irritating echoes.

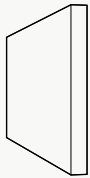

Single Layer  
½" Thickness

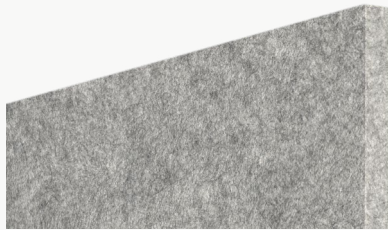

### Soundcore® Wood Textures

Soundcore® wood textures provide the natural aesthetic of wood while maintaining all the acoustic benefits of PET felt. Custom texture opportunities are also available upon request.

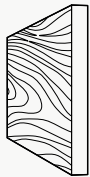

Single Layer  
½" Thickness



### PoshFelt® Exposed Edge

100% organic, natural wool design felt brings out the best experience in your space with color, comfort, and simple sustainability. Exposed edge products leave the Soundcore® layer uncovered, allowing for unique color combinations.

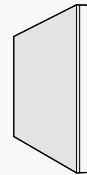

Multi-Layer  
Adds ⅛"-¼" to Material Thickness



PoshFelt® | 3mm Thickness



**PSH005**  
Black Beauty

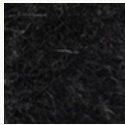

**PSH161**  
Black Swan



**PSH266**  
Koala

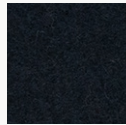

**PSH627**  
Blackberry



**PSH265**  
Slag



**PSH513**  
Gravel



**PSH001**  
Gray Matter

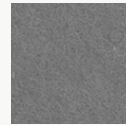

**PSH004**  
Porpoise

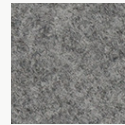

**PSH176**  
Warmstone

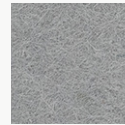

**PSH512**  
Ash Plume



**PSH545**  
Henna

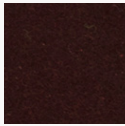

**PSH249**  
French Press



**PSH146**  
Auburn



**PSH521**  
Cocoa

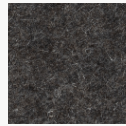

**PSH179**  
Arctic Seal

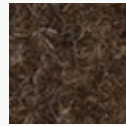

**PSH180**  
Iron Ore



**PSH505**  
Garrigue

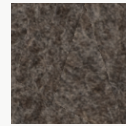

**PSH003**  
Otter



**PSH520**  
Silt

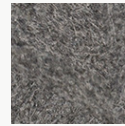

**PSH002**  
Heather



**PSH504**  
Earth



**PSH255**  
Tropical Walnut



**PSH269**  
Canyon



**PSH253**  
Toffee



**PSH602**  
Cafe



**PSH281**  
Great Plains



**PSH503**  
Savanna



**PSH509**  
Cairo



**PSH621**  
Pan

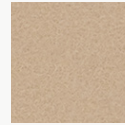

**PSH291**  
Gobi

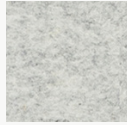

**PSH299**  
Mountain Breeze



**PSH300**  
Crevasse

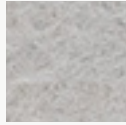

**PSH625**  
Silver Chain

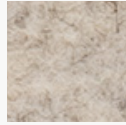

**PSH515**  
Blizzard

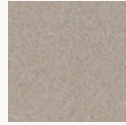

**PSH127**  
Mocha

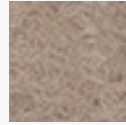

**PSH635**  
Eggshell



**PSH178**  
Fawn



**PSH175**  
Dovetail

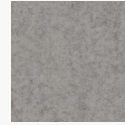

**PSH624**  
Dapple Gray

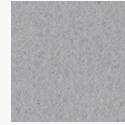

**PSH609**  
Cityscape

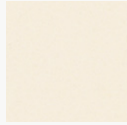

**PSH118**  
Ivory Lace

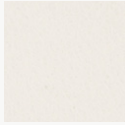

**PSH174**  
Cotton



**PSH293**  
Pound Cake



**PSH519\***  
Cupcake



**PSH630**  
Sand Dune

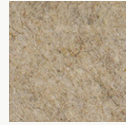

**PSH006**  
Shiitake

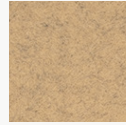

**PSH301**  
Tumbleweed



**PSH637**  
Chiffon



**PSH304**  
Sugar Cookie



**PSH541**  
Banana Bread













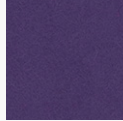





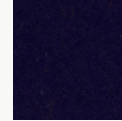
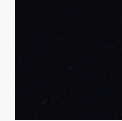

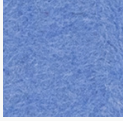

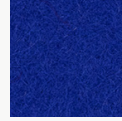
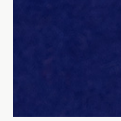



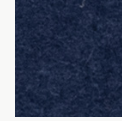



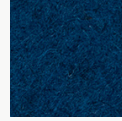

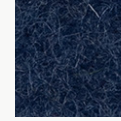

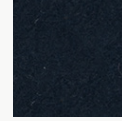

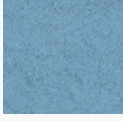
\*6-roll MOQ

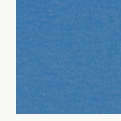

PoshFelt® | 3mm Thickness

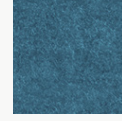
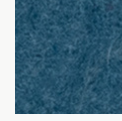
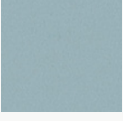
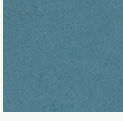
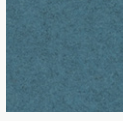
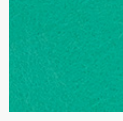
									
<b>PSH215</b> Raincoat	<b>PSH622</b> Corn	<b>PSH295</b> Sunrise Peach	<b>PSH507</b> Hive	<b>PSH015</b> Honey	<b>PSH305</b> Dandelion	<b>PSH216</b> Lion's Den	<b>PSH634</b> Amber	<b>PSH261</b> Pale Ale	<b>PSH638</b> Sunflower
									
<b>PSH610</b> Coral	<b>PSH632</b> Peach	<b>PSH218</b> Citrus	<b>PSH532</b> Harvest	<b>PSH014</b> Knockout Orange	<b>PSH307</b> Orange Nectar	<b>PSH633</b> Clementine	<b>PSH245</b> Fire Agate	<b>PSH525</b> Olympus	<b>PSH640</b> Rusted
									
<b>PSH139</b> Cayenne	<b>PSH535</b> Guppy	<b>PSH528</b> Ferrous	<b>PSH296</b> Paprika	<b>PSH530</b> Hot Iron	<b>PSH537</b> Cardinal	<b>PSH008</b> Bonfire	<b>PSH308</b> Scarlet	<b>PSH009</b> Poinsettia	<b>PSH527</b> Red Velvet
									
<b>PSH137</b> Passion Flower	<b>PSH273</b> Ultraviolet	<b>PSH649</b> Pomegranate	<b>PSH617</b> Evening Gown	<b>PSH540</b> Devil's Food	<b>PSH644</b> Maroon	<b>PSH210</b> Sangria	<b>PSH211</b> Cherry Chutney	<b>PSH212</b> Vino	<b>PSH514</b> Red Wine
									
<b>PSH272</b> Hotwire	<b>PSH302</b> Heather Pink	<b>PSH202</b> Crush	<b>PSH647</b> Eden Rose	<b>PSH643</b> Rhododendron	<b>PSH560</b> Schiava	<b>PSH559</b> Monroe	<b>PSH544</b> Dragonfruit	<b>PSH309</b> Allium	<b>PSH205</b> Mulberry

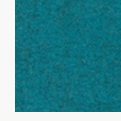
PoshFelt® | 3mm Thickness

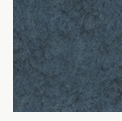
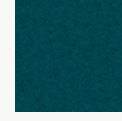
									
PSH612 Lilac	PSH646 Lupine	PSH274 Amethyst	PSH523 Violet Sky	PSH546 Tyrian Plum	PSH142 Plum Purple	PSH286 Viper	PSH241 Tranquilo	PSH550 Mariana	PSH277 Shade
									
PSH615 Imagine	PSH510 Ozone	PSH237 Hotspring	PSH508 Oahu	PSH548 Ultramarine	PSH160 Admiral Blue	PSH239 Speckled Navy	PSH561 Neptune	PSH645 Space	PSH614 Blueberry
									
PSH502 Pacific	PSH238 Cobalt	PSH152 Blue Nile	PSH616 Fountain	PSH516 Actun	PSH511 Lagoon	PSH636 Navy Blue	PSH260 Twilight	PSH310 Deep Royal	PSH278 Squid Ink
									
PSH606 Midday	PSH306 Swell	PSH608 Diamond Dust	PSH605 Meander	PSH628 Cozumel	PSH016 Freshwater	PSH650 Waterfall	PSH149 Jamaica Bay	PSH604 Atlantic	PSH648 Aegean
									
PSH639 Glacier	PSH287 Sea Breeze	PSH631 Adriatic	PSH232 Seaglass	PSH629 Robin's Egg	PSH517 Sky Stone	PSH552 Cancun	PSH642 Blue Spruce	PSH623 Steel Gray	PSH564 Jazz

PoshFelt® | 3mm Thickness



**PSH618**  
Iguana



**PSH641**  
Basil

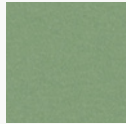

**PSH619**  
Springtime

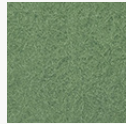

**PSH213**  
Meadow

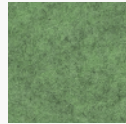

**PSH303**  
Feather Moss



**PSH226**  
Grove



**PSH298**  
Peacock



**PSH234**  
Ocean Trench



**PSH311**  
Emerald



**PSH626**  
Evergreen



**PSH225**  
Everglade



**PSH164**  
Fresh Lime



**PSH554**  
Cyber Green



**PSH555**  
Hemlocks



**PSH012**  
Shamrock

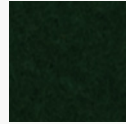

**PSH228**  
Forest Haze

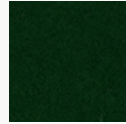

**PSH227**  
Succulent

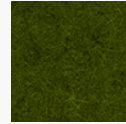

**PSH563**  
Rosemary

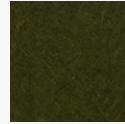

**PSH501**  
Mire



**PSH506**  
Bracken

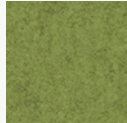

**PSH562**  
Aurora

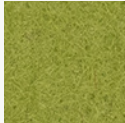

**PSH556**  
Avocado

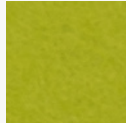

**PSH013**  
Parakeet

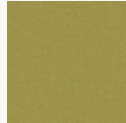

**PSH611**  
Haybale

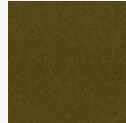

**PSH312**  
Safari

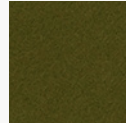

**PSH230**  
Camouflage

Soundcore® | 1/2" Thickness

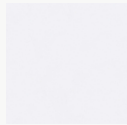

SND019  
Linen

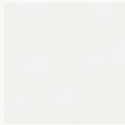

SND037  
Paper

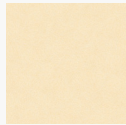

SND134  
Oat



SND135  
Vanilla Bean



SND105  
Sand Dollar



SND109  
Macadamia



SND111  
Lanai



SND130  
Buckskin

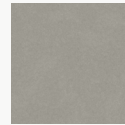

SND131  
Abalone

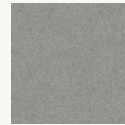

SND125  
Chinchilla



SND118  
Anchor



SND126  
Wolfhound



SND110  
Starry Night



SND102  
Morning Fog

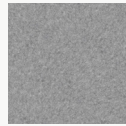

SND114  
Lunar Dust

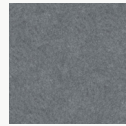

SND034  
Granite Peak

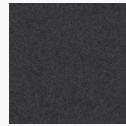

SND132  
Cast Iron

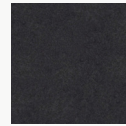

SND103  
Storm Cloud



SND038  
Inkwell



SND122  
Briquette



SND127  
Burnt Toast



SND108  
Ablaze



SND104  
Pumpkin



SND106  
Goldfinch

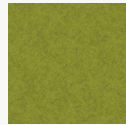

SND113  
Gruner

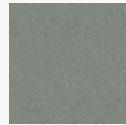

SND129  
Dried Thyme



SND107  
Grasshopper

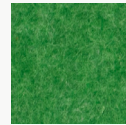

SND136  
Clover



SND138  
Fern

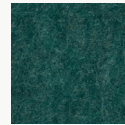

SND137  
Cove



SND112  
Tulum



SND139  
Tidal



SND121  
Apatite

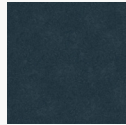

SND123  
Chrysocolla



SND117  
Serene



SND124  
Ice Floe

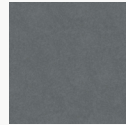

SND115  
Mako

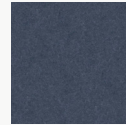

SND128  
Arctic Ocean

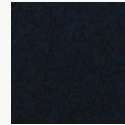

SND133  
Galactic



SND116  
Blue Marlin

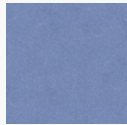

SND042  
Denim



SND140  
Marine

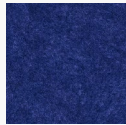

SND101  
Commodore

Soundcore® Wood Textures | 1/2" Thickness



**SND716**  
Dark Teak

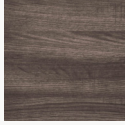

**SND792**  
Dark Oak

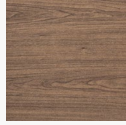

**SND715**  
Dark Cherry

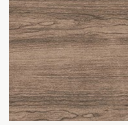

**SND793**  
Vintage Maple

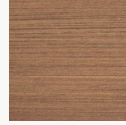

**SND794**  
Warm Teak

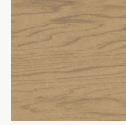

**SND714**  
English Walnut

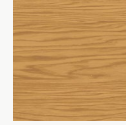

**SND713**  
Honey Walnut

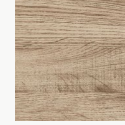

**SND717**  
Warm Oak

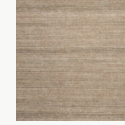

**SND790**  
Natural Teak

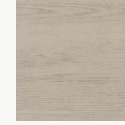

**SND712**  
Natural Spruce



**SND711**  
Bleached Cherry



**SND795**  
Light Teak

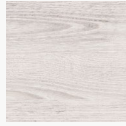

**SND709**  
White Maple



**SND791**  
Gray Oak



**SND710**  
Gray Teak