

Product Specifications

Product Name	Carved Surfaces 012
Product ID	SUR-CRV-012
Acoustics	0.40 - 0.50 NRC*
Lead Time	Lead time is dependent on project size. Contact us for more information.
Durability	Contract

Warranty	Comes with industry-leading standard warranty.
Flammability	ASTM E84: Class A
Custom	Custom colors and manufacturing services available. Additional charges and lead times may apply.
Maintenance	Vacuum occasionally to remove airborne dust or debris. Mild detergents or soaps may be used to remove stains. For detailed care instructions, refer to the CSI Creative Maintenance Information document.

Material Specifications

	Soundcore®	PoshFelt®
Content	Recycled PET acoustic felt	100% Merino or Karakul wool acoustic felt
Weathering	Colorfast, non-deteriorating, non-hygroscopic	Colorfast, non-deteriorating, non-woven, moisture resistant
Environmental	Recycled PET acoustic felt is 60% post-consumer recycled content and is 100% recyclable. Contributes points toward LEED v4, CDPH v1.2, VOC free, non-toxic, non-allergenic, anti-microbial - does not attract mold and mildew. Compliant with Living Building Challenge criteria & DECLARE Red List Free.	100% organic wool design felt is a rapidly renewable resource and is 100% biodegradable/compostable. Contributes points toward LEED v4, CDPH v1.2, VOC free, no chemical irritants, no formaldehyde, and is free of other harmful substances. Compliant with Living Building Challenge criteria & DECLARE Red List Free.
Variation	PET felt panels are created through a manufacturing process known as 'felting'. This process results in a heathered appearance. Multiple color tones may appear in the same panel. Slight color variations should be expected.	Due to its 100% natural origin, the raw fibers of wool felt contain inclusions and color variations throughout the material. Color matching is not guaranteed between dye lots and inconsistencies may be more prominent in volumes that exceed the normal commercial standard.

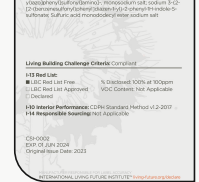
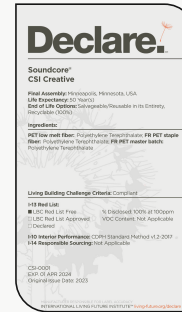

*Approximate. NRC rating may vary due to product dimensions and spacing.

Dimensions

Standard Unit Dimensions

Typical ranges for height and width.

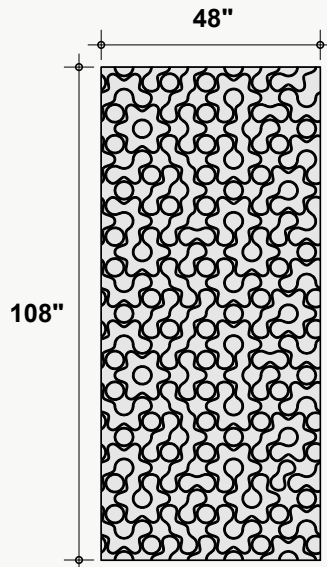

Custom Opportunity

Product dimensions can be manipulated in order to fit your design aesthetic and site conditions.

Standard Unit Thicknesses

Thickness is dependent on material layer selection.

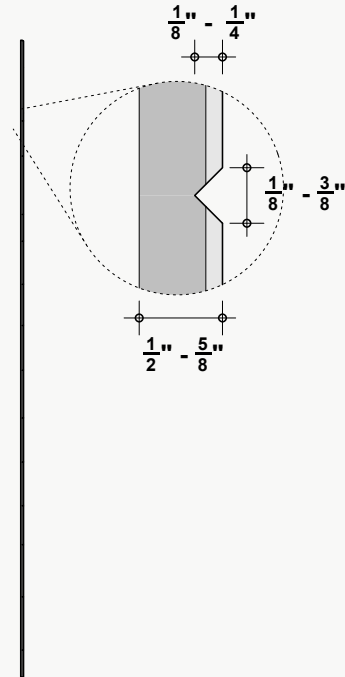

Product Details

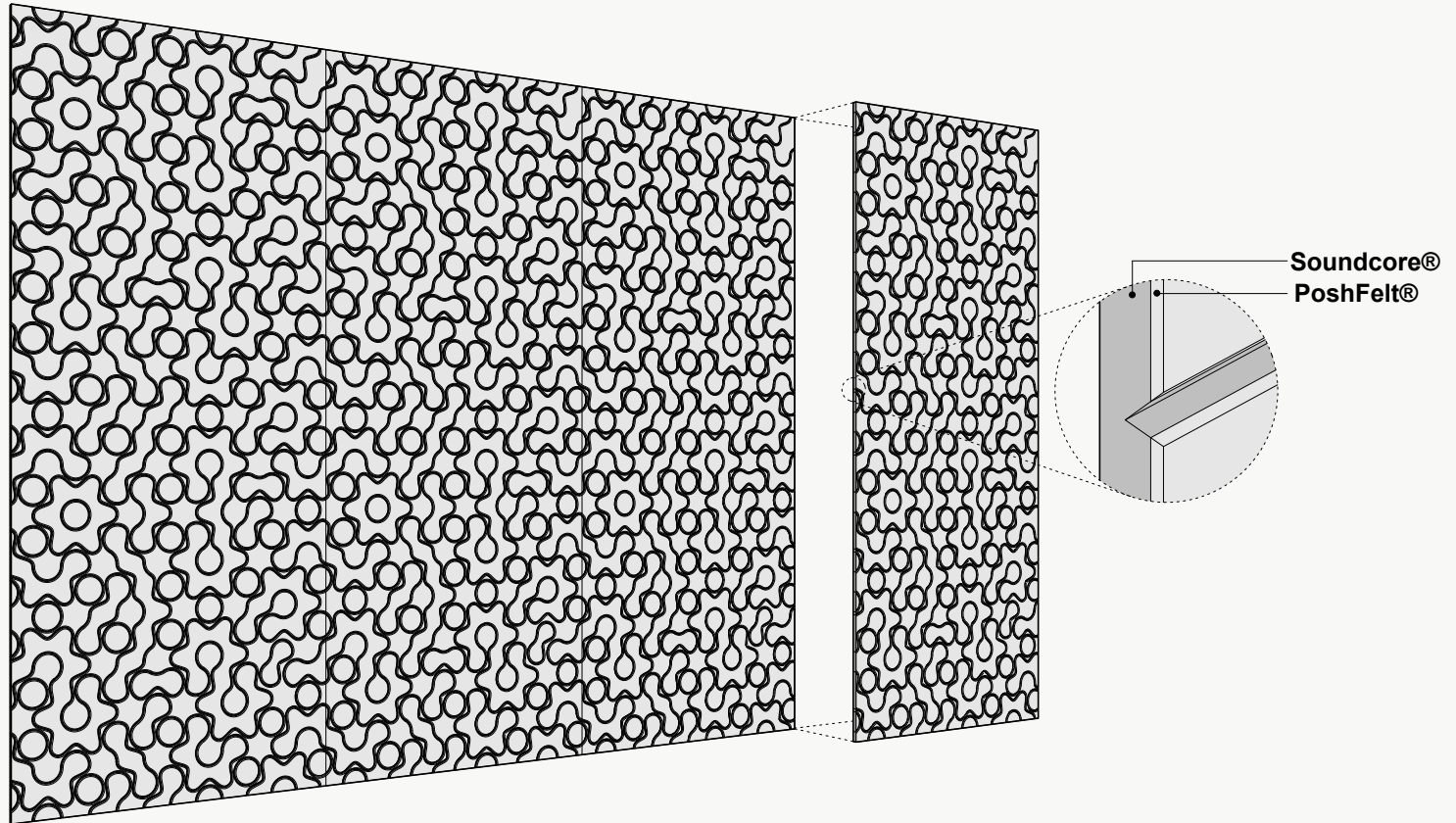

Installation Options*

All products and installation methods can be **customized** to meet the unique requirements of your space.

Adhesive Direct Advantages

Attachment solution using an adhesive to apply directly to an existing surface or substrate.

- + Fastest installation time
- + No gap between target surface and product
- + Lowest profile installation option
- + Easiest to install
- + Most versatile installation option

Available methods: Construction Adhesive, Peel & Stick, Custom

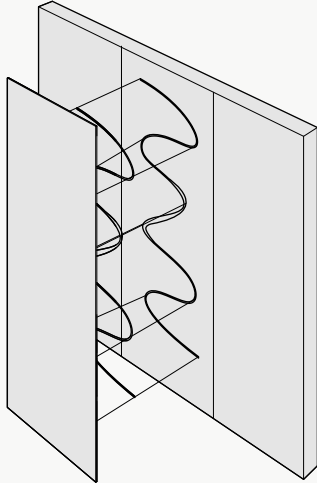

Mechanical Direct Advantages

Attachment solution using physical hardware to attach to an existing surface or substrate.

- + No clamping or dry time necessary
- + Easy to remove and does not damage the substrate when removed
- + Most appropriate installation solution for heavier products
- + Provides an opportunity for an air gap, which can increase the acoustic value of a product

Available methods: Z-Clips, Panel Clips, Standoffs, Screw & Washer, Magnet, Custom

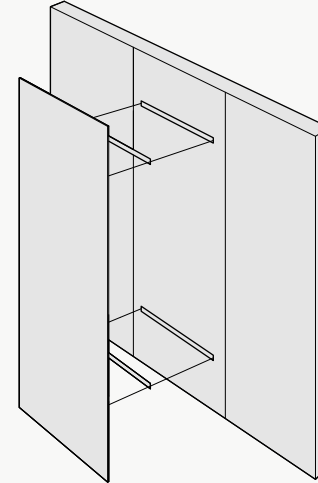

*Not all listed attachment methods may be applicable to this product.

Material Layers

Soundcore®

Our recycled PET felt creates an acoustic barrier, defending against wandering white noise and irritating echoes.

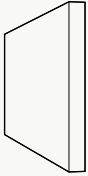

Single Layer
½" Thickness

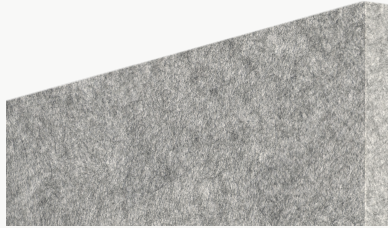

PoshFelt® Exposed Edge

100% organic, natural wool design felt brings out the best experience in your space with color, comfort, and simple sustainability. Exposed edge products leave the Soundcore® layer uncovered, allowing for unique color combinations.

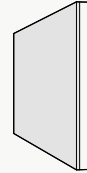

Multi-Layer
Adds ⅛"-¼" to Material Thickness



Soundcore® Wood Textures









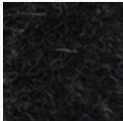
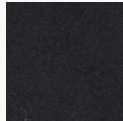
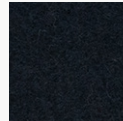
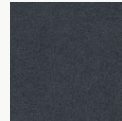

Soundcore® wood textures provide the natural aesthetic of wood while maintaining all the acoustic benefits of PET felt. Custom texture opportunities are also available upon request.

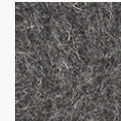
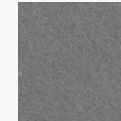

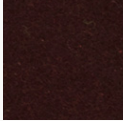
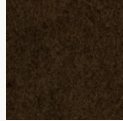
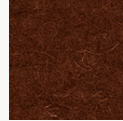
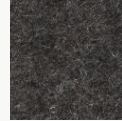
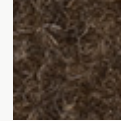
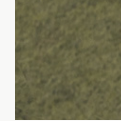
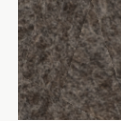
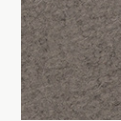
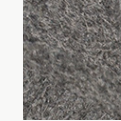
Single Layer
½" Thickness

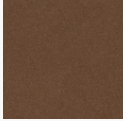

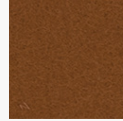
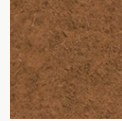
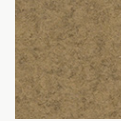
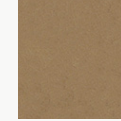
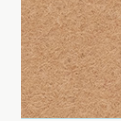
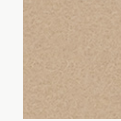
PoshFelt® | 3mm Thickness

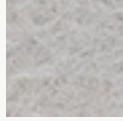
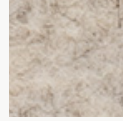
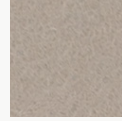
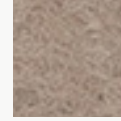
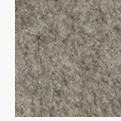
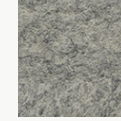
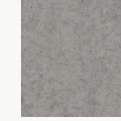
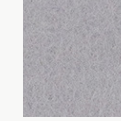
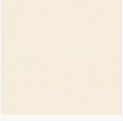
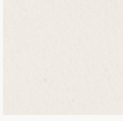
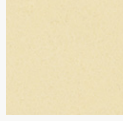
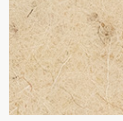
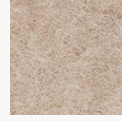
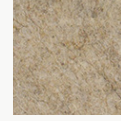
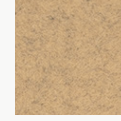
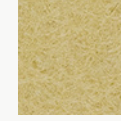
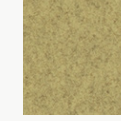
									
PSH005 Black Beauty	PSH161 Black Swan	PSH266 Koala	PSH627 Blackberry	PSH265 Slag	PSH513 Gravel	PSH001 Gray Matter	PSH004 Porpoise	PSH176 Warmstone	PSH512 Ash Plume
									
PSH545 Henna	PSH249 French Press	PSH146 Auburn	PSH521 Cocoa	PSH179 Arctic Seal	PSH180 Iron Ore	PSH505 Garrigue	PSH003 Otter	PSH520 Silt	PSH002 Heather
									
PSH504 Earth	PSH255 Tropical Walnut	PSH269 Canyon	PSH253 Toffee	PSH602 Cafe	PSH281 Great Plains	PSH503 Savanna	PSH509 Cairo	PSH621 Pan	PSH291 Gobi
									
PSH299 Mountain Breeze	PSH300 Crevasse	PSH625 Silver Chain	PSH515 Blizzard	PSH127 Mocha	PSH635 Eggshell	PSH178 Fawn	PSH175 Dovetail	PSH624 Dapple Gray	PSH609 Cityscape
									
PSH118 Ivory Lace	PSH174 Cotton	PSH293 Pound Cake	PSH519* Cupcake	PSH630 Sand Dune	PSH006 Shiitake	PSH301 Tumbleweed	PSH637 Chiffon	PSH304 Sugar Cookie	PSH541 Banana Bread

*6-roll MOQ

PoshFelt® | 3mm Thickness



PSH215
Raincoat



PSH622
Corn



PSH295
Sunrise Peach



PSH507
Hive



PSH015
Honey



PSH305
Dandelion

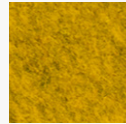

PSH216
Lion's Den



PSH634
Amber



PSH261
Pale Ale



PSH638
Sunflower



PSH610
Coral



PSH632
Peach



PSH218
Citrus



PSH532
Harvest



PSH014
Knockout Orange

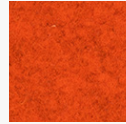

PSH307
Orange Nectar



PSH633
Clementine



PSH245
Fire Agate



PSH525
Olympus



PSH640
Rusted

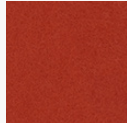

PSH139
Cayenne



PSH535
Guppy

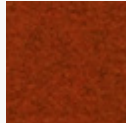

PSH528
Ferrous



PSH296
Paprika



PSH530
Hot Iron

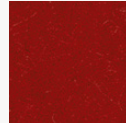

PSH537
Cardinal

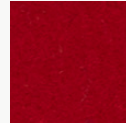

PSH008
Bonfire



PSH308
Scarlet

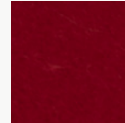

PSH009
Poinsettia

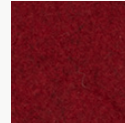

PSH527
Red Velvet



PSH137
Passion Flower



PSH273
Ultraviolet

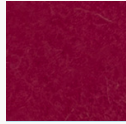

PSH649
Pomegranate



PSH617
Evening Gown

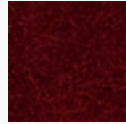

PSH540
Devil's Food

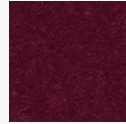

PSH644
Maroon

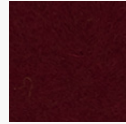

PSH210
Sangria

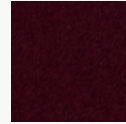

PSH211
Cherry Chutney



PSH212
Vino

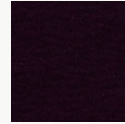

PSH514
Red Wine



PSH272
Hotwire



PSH302
Heather Pink



PSH202
Crush

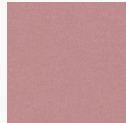

PSH647
Eden Rose

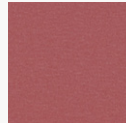

PSH643
Rhododendron



PSH560
Schiava

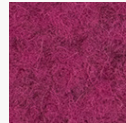

PSH559
Monroe

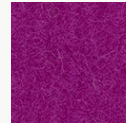

PSH544
Dragonfruit



PSH309
Allium

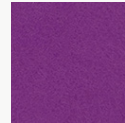

PSH205
Mulberry

PoshFelt® | 3mm Thickness

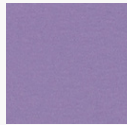

PSH612
Lilac



PSH646
Lupine



PSH274
Amethyst



PSH523
Violet Sky



PSH546
Tyrian Plum



PSH142
Plum Purple



PSH286
Viper

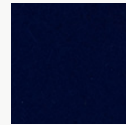

PSH241
Tranquilo

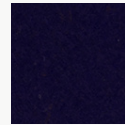

PSH550
Mariana

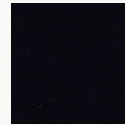

PSH277
Shade

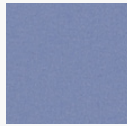

PSH615
Imagine

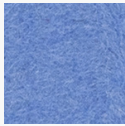

PSH510
Ozone



PSH237
Hotspring



PSH508
Oahu

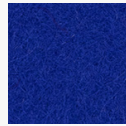

PSH548
Ultramarine



PSH160
Admiral Blue



PSH239
Speckled Navy



PSH561
Neptune



PSH645
Space



PSH614
Blueberry



PSH502
Pacific



PSH238
Cobalt



PSH152
Blue Nile



PSH616
Fountain

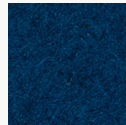

PSH516
Actun

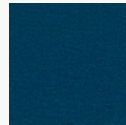

PSH511
Lagoon

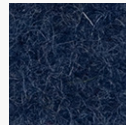

PSH636
Navy Blue



PSH260
Twilight

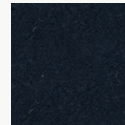

PSH310
Deep Royal



PSH278
Squid Ink



PSH606
Midday



PSH306
Swell

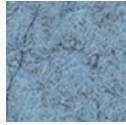

PSH608
Diamond Dust

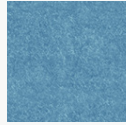

PSH605
Meander



PSH628
Cozumel



PSH016
Freshwater



PSH650
Waterfall



PSH149
Jamaica Bay

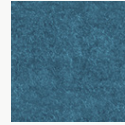

PSH604
Atlantic



PSH648
Aegean

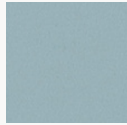

PSH639
Glacier



PSH287
Sea Breeze



PSH631
Adriatic



PSH232
Seaglass



PSH629
Robin's Egg



PSH517
Sky Stone



PSH552
Cancun

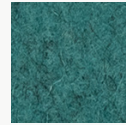

PSH642
Blue Spruce



PSH623
Steel Gray



PSH564
Jazz

PoshFelt® | 3mm Thickness



PSH618
Iguana



PSH641
Basil

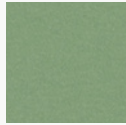

PSH619
Springtime

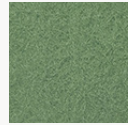

PSH213
Meadow

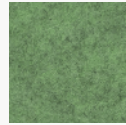

PSH303
Feather Moss



PSH226
Grove



PSH298
Peacock



PSH234
Ocean Trench



PSH311
Emerald

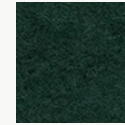

PSH626
Evergreen



PSH225
Everglade



PSH164
Fresh Lime



PSH554
Cyber Green



PSH555
Hemlocks

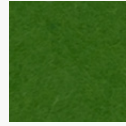

PSH012
Shamrock

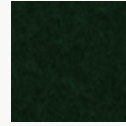

PSH228
Forest Haze

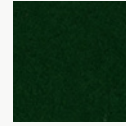

PSH227
Succulent

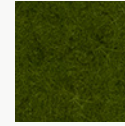

PSH563
Rosemary

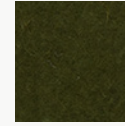

PSH501
Mire

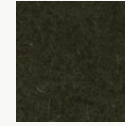

PSH506
Bracken



PSH562
Aurora

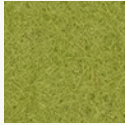

PSH556
Avocado



PSH013
Parakeet



PSH611
Haybale



PSH312
Safari



PSH230
Camouflage

Soundcore® | 1/2" Thickness



SND019
Linen



SND037
Paper



SND134
Oat



SND135
Vanilla Bean



SND105
Sand Dollar



SND109
Macadamia



SND111
Lanai



SND130
Buckskin



SND131
Abalone

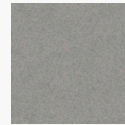

SND125
Chinchilla



SND118
Anchor



SND126
Wolfhound



SND110
Starry Night



SND102
Morning Fog

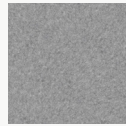

SND114
Lunar Dust



SND034
Granite Peak

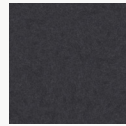

SND132
Cast Iron

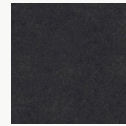

SND103
Storm Cloud



SND038
Inkwell



SND122
Briquette



SND127
Burnt Toast



SND108
Ablaze



SND104
Pumpkin



SND141
Terracotta



SND106
Goldfinch



SND107
Grasshopper



SND113
Gruner



SND143
Olive

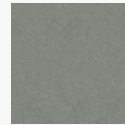

SND129
Dried Thyme



SND115
Mako



SND136
Clover



SND138
Fern

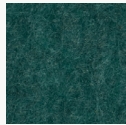

SND137
Cove



SND112
Tulum



SND139
Tidal



SND121
Apatite

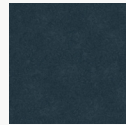

SND123
Chrysocolla



SND117
Serene



SND124
Ice Floe

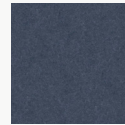

SND128
Arctic Ocean

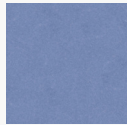

SND042
Denim

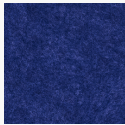

SND101
Commodore



SND140
Marine



SND133
Galactic



SND142
Fig

Soundcore® Wood Textures | 1/2" Thickness



SND716
Dark Teak



SND792
Dark Oak



SND715
Dark Cherry



SND793
Vintage Maple



SND794
Warm Teak



SND714
English Walnut



SND713
Honey Walnut



SND717
Warm Oak



SND790
Natural Teak

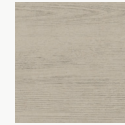

SND712
Natural Spruce



SND711
Bleached Cherry

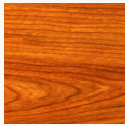

SND796
Vintage Cherry



SND795
Light Teak



SND709
White Maple

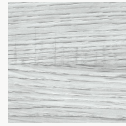

SND791
Gray Oak



SND710
Gray Teak