

# Product Specifications

<b>Product Name</b>	Blade Surfaces 006
<b>Product ID</b>	SUR-BLD-006
<b>Acoustics</b>	0.70 - 0.90 NRC*
<b>Lead Time</b>	Lead time is dependent on project size. Contact us for more information.
<b>Durability</b>	Contract

<b>Warranty</b>	Comes with industry-leading standard warranty.
<b>Flammability</b>	ASTM E84: Class A
<b>Custom</b>	Custom colors and manufacturing services available. Additional charges and lead times may apply.
<b>Maintenance</b>	Vacuum occasionally to remove airborne dust or debris. Mild detergents or soaps may be used to remove stains. For detailed care instructions, refer to the <b>CSI Creative Maintenance Information</b> document.

# Material Specifications

	<b>Soundcore®</b>	<b>PoshFelt®</b>
<b>Content</b>	Recycled PET acoustic felt	100% Merino or Karakul wool acoustic felt
<b>Weathering</b>	Colorfast, non-deteriorating, non-hygroscopic	Colorfast, non-deteriorating, non-woven, moisture resistant
<b>Environmental</b>	Recycled PET acoustic felt is 60% post-consumer recycled content and is 100% recyclable. Contributes points toward LEED v4, CDPH v1.2, VOC free, non-toxic, non-allergenic, anti-microbial - does not attract mold and mildew. Compliant with Living Building Challenge criteria & DECLARE Red List Free.	100% organic wool design felt is a rapidly renewable resource and is 100% biodegradable/compostable. Contributes points toward LEED v4, CDPH v1.2, VOC free, no chemical irritants, no formaldehyde, and is free of other harmful substances. Compliant with Living Building Challenge criteria & DECLARE Red List Free.
<b>Variation</b>	PET felt panels are created through a manufacturing process known as 'felting'. This process results in a heathered appearance. Multiple color tones may appear in the same panel. Slight color variations should be expected.	Due to its 100% natural origin, the raw fibers of wool felt contain inclusions and color variations throughout the material. Color matching is not guaranteed between dye lots and inconsistencies may be more prominent in volumes that exceed the normal commercial standard.

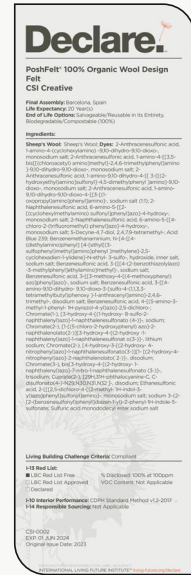
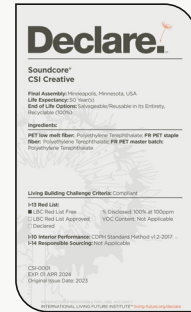

\*Approximate. NRC rating may vary due to product dimensions and spacing.

# Dimensions

## Standard Unit Dimensions

Typical ranges for height and width.

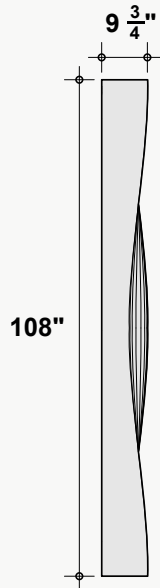

## Custom Opportunity

Product dimensions can be manipulated in order to fit your design aesthetic and site conditions.

## Standard Unit Thicknesses

Thickness is dependent on material layer selection.

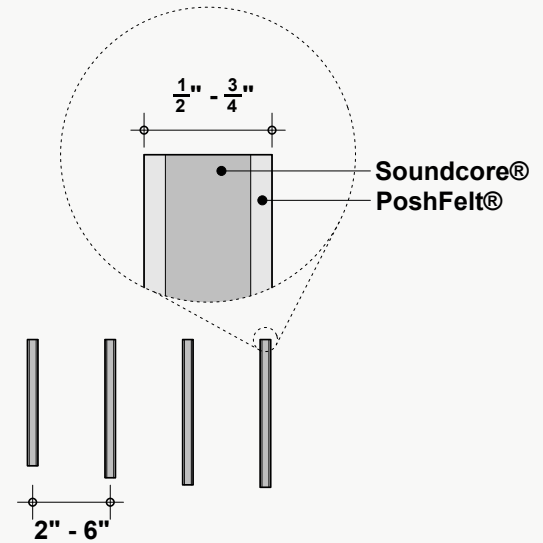

## Product Details

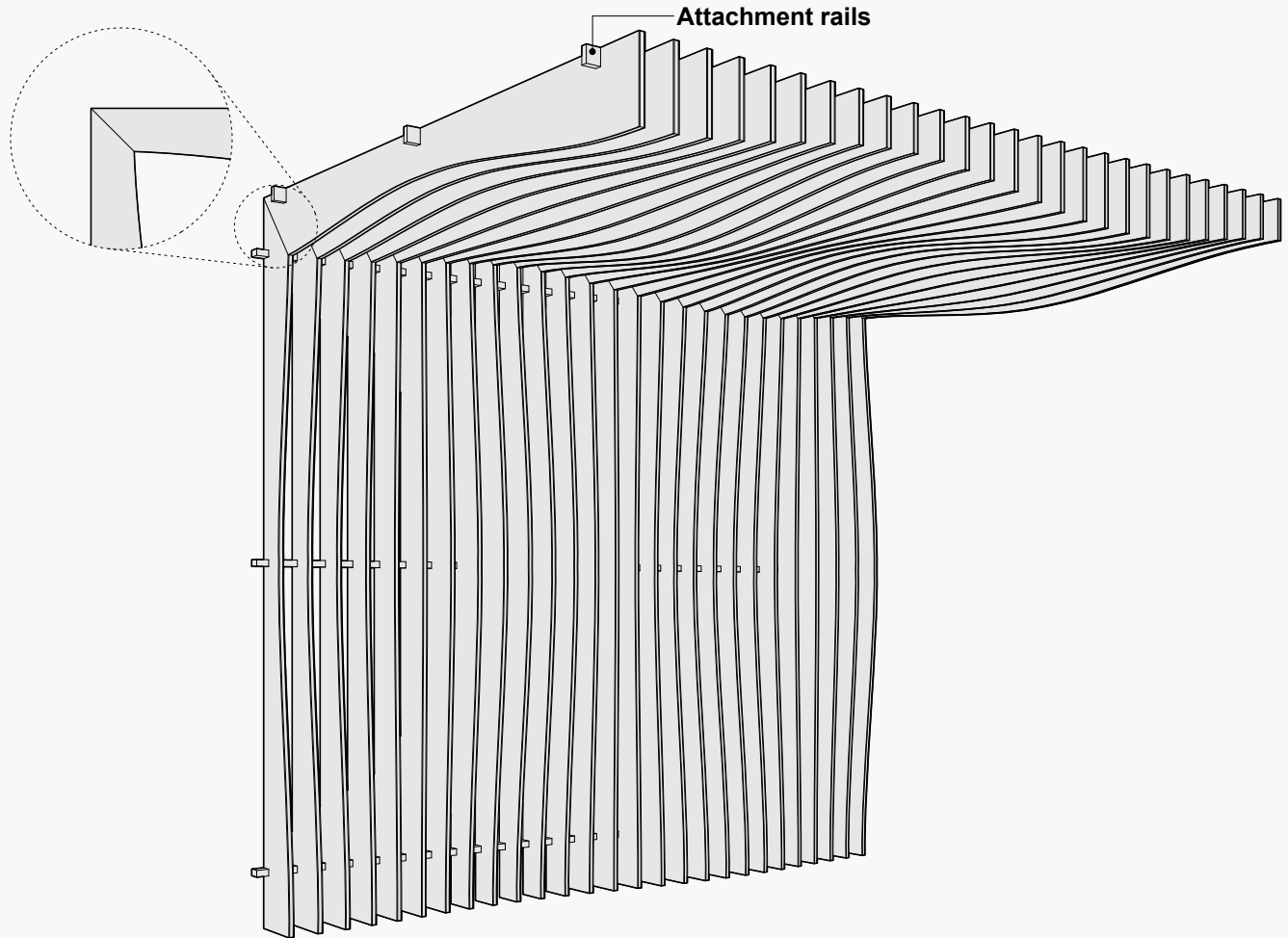

# Installation Options\*

All products and installation methods can be **customized** to meet the unique requirements of your space.

## Individual

Attachment solution allowing for independent installation of units.

- + Allows for multiple unit orientations
- + No visible hardware

Available methods: Panel Clip, Metal Bracket

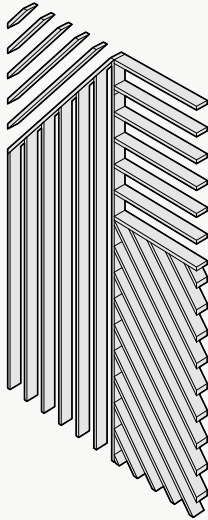

## Rail

Attachment solution using physical hardware to attach to an existing surface or substrate.

- + Controlled unit spacing and orientation
- + Fastest installation time
- + Lowest labor cost

Available methods: Linear Rail

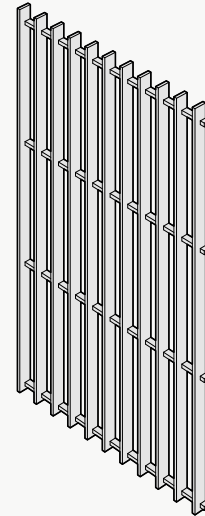

\*Not all listed attachment methods may be applicable to this product.

# Material Layers

## Soundcore®

Our recycled PET felt creates an acoustic barrier, defending against wandering white noise and irritating echoes.

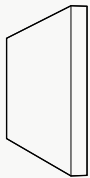

**Single Layer**  
½" Thickness

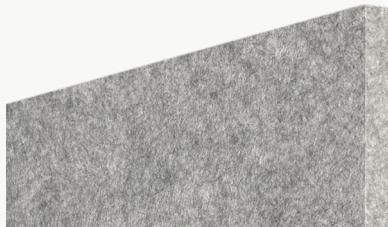

## PoshFelt® Exposed Edge

100% organic, natural wool design felt brings out the best experience in your space with color, comfort, and simple sustainability. Exposed edge products leave the Soundcore® layer uncovered, allowing for unique color combinations.

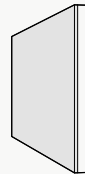

**Multi-Layer**  
Adds ⅛"-¼" to Material Thickness



## Soundcore® Wood Textures

Soundcore® wood textures provide the natural aesthetic of wood while maintaining all the acoustic benefits of PET felt. Custom texture opportunities are also available upon request.



**Single Layer**  
½" Thickness



PoshFelt® | 3mm Thickness



**PSH005**  
Black Beauty



**PSH161**  
Black Swan



**PSH266**  
Koala



**PSH627**  
Blackberry

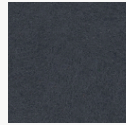

**PSH265**  
Slag



**PSH513**  
Gravel

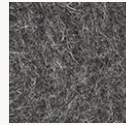

**PSH001**  
Gray Matter

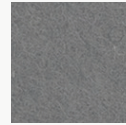

**PSH004**  
Porpoise

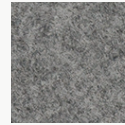

**PSH176**  
Warmstone

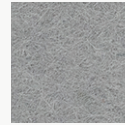

**PSH512**  
Ash Plume

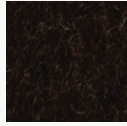

**PSH545**  
Henna

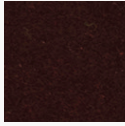

**PSH249**  
French Press



**PSH146**  
Auburn



**PSH521**  
Cocoa

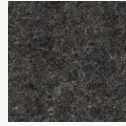

**PSH179**  
Arctic Seal

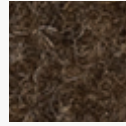

**PSH180**  
Iron Ore



**PSH505**  
Garrigue



**PSH003**  
Otter

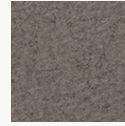

**PSH520**  
Silt

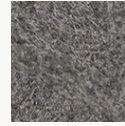

**PSH002**  
Heather



**PSH504**  
Earth



**PSH255**  
Tropical Walnut



**PSH269**  
Canyon



**PSH253**  
Toffee



**PSH602**  
Cafe



**PSH281**  
Great Plains



**PSH503**  
Savanna



**PSH509**  
Cairo



**PSH621**  
Pan



**PSH291**  
Gobi



**PSH299**  
Mountain Breeze



**PSH300**  
Crevasse



**PSH625**  
Silver Chain

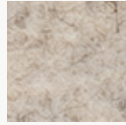

**PSH515**  
Blizzard

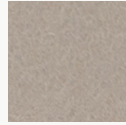

**PSH127**  
Mocha

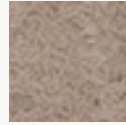

**PSH635**  
Eggshell



**PSH178**  
Fawn

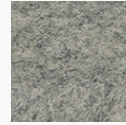

**PSH175**  
Dovetail



**PSH624**  
Dapple Gray



**PSH609**  
Cityscape

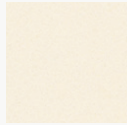

**PSH118**  
Ivory Lace

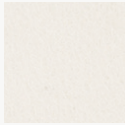

**PSH174**  
Cotton



**PSH293**  
Pound Cake



**PSH519\***  
Cupcake



**PSH630**  
Sand Dune



**PSH006**  
Shiitake



**PSH301**  
Tumbleweed



**PSH637**  
Chiffon



**PSH304**  
Sugar Cookie



**PSH541**  
Banana Bread

\*6-roll MOQ



PoshFelt® | 3mm Thickness



**PSH215**  
Raincoat



**PSH622**  
Corn



**PSH295**  
Sunrise Peach



**PSH507**  
Hive



**PSH015**  
Honey



**PSH305**  
Dandelion



**PSH216**  
Lion's Den



**PSH634**  
Amber



**PSH261**  
Pale Ale



**PSH638**  
Sunflower



**PSH610**  
Coral



**PSH632**  
Peach



**PSH218**  
Citrus



**PSH532**  
Harvest



**PSH014**  
Knockout Orange



**PSH307**  
Orange Nectar



**PSH633**  
Clementine



**PSH245**  
Fire Agate



**PSH525**  
Olympus



**PSH640**  
Rusted



**PSH139**  
Cayenne



**PSH535**  
Guppy



**PSH528**  
Ferrous



**PSH296**  
Paprika



**PSH530**  
Hot Iron



**PSH537**  
Cardinal



**PSH008**  
Bonfire



**PSH308**  
Scarlet



**PSH009**  
Poinsettia

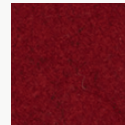

**PSH527**  
Red Velvet



**PSH137**  
Passion Flower



**PSH273**  
Ultraviolet



**PSH649**  
Pomegranate



**PSH617**  
Evening Gown

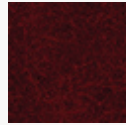

**PSH540**  
Devil's Food



**PSH644**  
Maroon



**PSH210**  
Sangria

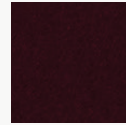

**PSH211**  
Cherry Chutney



**PSH212**  
Vino

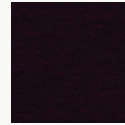

**PSH514**  
Red Wine



**PSH272**  
Hotwire



**PSH302**  
Heather Pink



**PSH202**  
Crush



**PSH647**  
Eden Rose

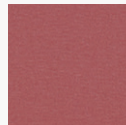

**PSH643**  
Rhododendron

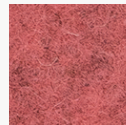

**PSH560**  
Schiava

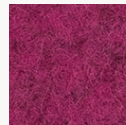

**PSH559**  
Monroe



**PSH544**  
Dragonfruit



**PSH309**  
Allium



**PSH205**  
Mulberry

PoshFelt® | 3mm Thickness



PSH612  
Lilac



PSH646  
Lupine



PSH274  
Amethyst



PSH523  
Violet Sky



PSH546  
Tyrian Plum



PSH142  
Plum Purple



PSH286  
Viper



PSH241  
Tranquilo

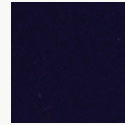

PSH550  
Mariana



PSH277  
Shade



PSH615  
Imagine

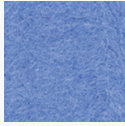

PSH510  
Ozone



PSH237  
Hotspring



PSH508  
Oahu

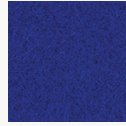

PSH548  
Ultramarine



PSH160  
Admiral Blue



PSH239  
Speckled Navy



PSH561  
Neptune



PSH645  
Space



PSH614  
Blueberry



PSH502  
Pacific



PSH238  
Cobalt



PSH152  
Blue Nile



PSH616  
Fountain

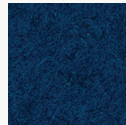

PSH516  
Actun



PSH511  
Lagoon

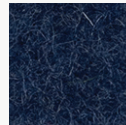

PSH636  
Navy Blue



PSH260  
Twilight

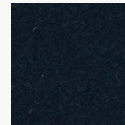

PSH310  
Deep Royal



PSH278  
Squid Ink



PSH606  
Midday



PSH306  
Swell

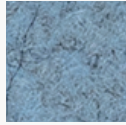

PSH608  
Diamond Dust



PSH605  
Meander



PSH628  
Cozumel



PSH016  
Freshwater



PSH650  
Waterfall



PSH149  
Jamaica Bay

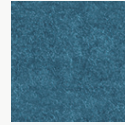

PSH604  
Atlantic



PSH648  
Aegean



PSH639  
Glacier



PSH287  
Sea Breeze



PSH631  
Adriatic



PSH232  
Seaglass



PSH629  
Robin's Egg

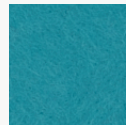

PSH517  
Sky Stone



PSH552  
Cancun



PSH642  
Blue Spruce



PSH623  
Steel Gray



PSH564  
Jazz

PoshFelt® | 3mm Thickness



**PSH618**  
Iguana



**PSH641**  
Basil



**PSH619**  
Springtime

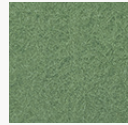

**PSH213**  
Meadow

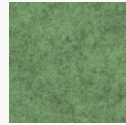

**PSH303**  
Feather Moss



**PSH226**  
Grove



**PSH298**  
Peacock



**PSH234**  
Ocean Trench



**PSH311**  
Emerald



**PSH626**  
Evergreen



**PSH225**  
Everglade



**PSH164**  
Fresh Lime



**PSH554**  
Cyber Green



**PSH555**  
Hemlocks



**PSH012**  
Shamrock



**PSH228**  
Forest Haze



**PSH227**  
Succulent



**PSH563**  
Rosemary



**PSH501**  
Mire



**PSH506**  
Bracken



**PSH562**  
Aurora



**PSH556**  
Avocado



**PSH013**  
Parakeet



**PSH611**  
Haybale

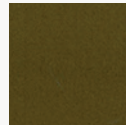

**PSH312**  
Safari

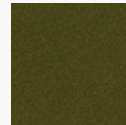

**PSH230**  
Camouflage

Soundcore® | 1/2" Thickness

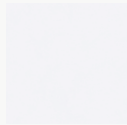

**SND019**  
Linen

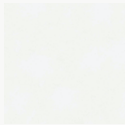

**SND037**  
Paper

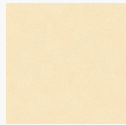

**SND134**  
Oat

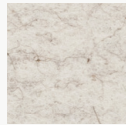

**SND135**  
Vanilla Bean



**SND105**  
Sand Dollar



**SND109**  
Macadamia



**SND111**  
Lanai



**SND130**  
Buckskin



**SND131**  
Abalone



**SND125**  
Chinchilla

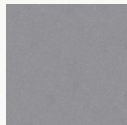

**SND118**  
Anchor



**SND126**  
Wolfhound

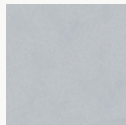

**SND110**  
Starry Night

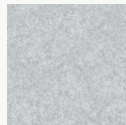

**SND102**  
Morning Fog

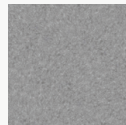

**SND114**  
Lunar Dust



**SND034**  
Granite Peak

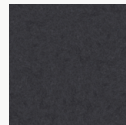

**SND132**  
Cast Iron

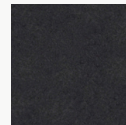

**SND103**  
Storm Cloud



**SND038**  
Inkwell



**SND122**  
Briquette



**SND127**  
Burnt Toast



**SND108**  
Ablaze



**SND104**  
Pumpkin



**SND106**  
Goldfinch



**SND113**  
Gruner



**SND107**  
Grasshopper



**SND136**  
Clover

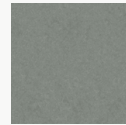

**SND129**  
Dried Thyme



**SND115**  
Mako

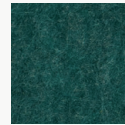

**SND137**  
Cove



**SND112**  
Tulum



**SND121**  
Apatite



**SND123**  
Chrysocolla



**SND117**  
Serene



**SND124**  
Ice Floe



**SND128**  
Arctic Ocean

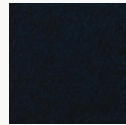

**SND133**  
Galactic



**SND116**  
Blue Marlin

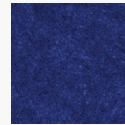

**SND101**  
Commodore



**SND042**  
Denim

Soundcore® Wood Textures | 1/2" Thickness



**SND716**  
Dark Teak



**SND792**  
Dark Oak



**SND715**  
Dark Cherry



**SND793**  
Vintage Maple



**SND794**  
Warm Teak

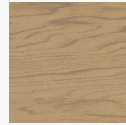

**SND714**  
English Walnut



**SND713**  
Honey Walnut



**SND717**  
Warm Oak

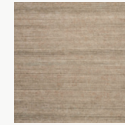

**SND790**  
Natural Teak

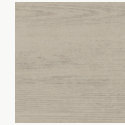

**SND712**  
Natural Spruce



**SND711**  
Bleached Cherry



**SND795**  
Light Teak



**SND709**  
White Maple

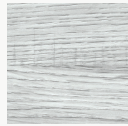

**SND791**  
Gray Oak

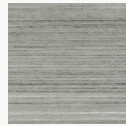

**SND710**  
Gray Teak